

# TOSHIBA



## DVD VIDEO PLAYER SD-3960SU

OWNER'S MANUAL



Introduction 2

Connections 18

Basic playback 26

Advanced playback 34

Function setup 60

Others 72



# SAFETY PRECAUTIONS

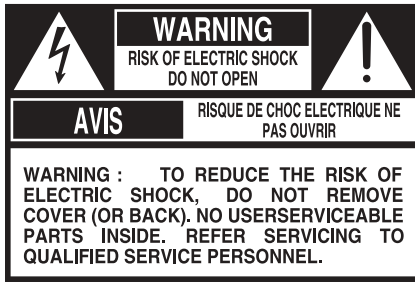

The lightning flash with arrowhead symbol, within an equilateral triangle, is intended to alert the user to the presence of uninsulated "dangerous voltage" within the product's enclosure that may be of sufficient magnitude to constitute a risk of electric shock to persons.



The exclamation point within an equilateral triangle is intended to alert the user to the presence of important operating and maintenance (servicing) instructions in the literature accompanying the appliance.



The symbol for CLASS II (Double Insulation)

**WARNING:** TO REDUCE THE RISK OF FIRE OR ELECTRIC SHOCK, DO NOT EXPOSE THIS APPLIANCE TO RAIN OR MOISTURE. DANGEROUS HIGH VOLTAGES ARE PRESENT INSIDE THE ENCLOSURE. DO NOT OPEN THE CABINET. REFER SERVICING TO QUALIFIED PERSONNEL ONLY.

**CAUTION:** TO PREVENT ELECTRIC SHOCK, MATCH WIDE BLADE OF PLUG TO WIDE SLOT, FULLY INSERT.

**ATTENTION:** POUR EVITER LES CHOCS ELECTRIQUES, INTRODUIRE LA LAME LA PLUS LARGE DE LA FICHE DANS LA BORNE CORRESPONDANTE DE LA PRISE ET POUSSER JUSQU'AU FOND.

**CAUTION:** This Digital Video Disc Player employs a Laser System. To ensure proper use of this product, please read this owner's manual carefully and retain for future reference. Should the unit require maintenance, contact an authorized service location - see service procedure.

Use of controls or adjustments or performance of procedures other than those specified herein may result in hazardous radiation exposure.

To prevent direct exposure to laser beam, do not try to open the enclosure. Visible and invisible laser radiation when open and interlocks defeated. DO NOT STARE INTO BEAM.

**FCC NOTICE:** This equipment has been tested and found to comply with the limits for a Class B digital device, pursuant to part 15 of the FCC Rule. These limits are designed to provide reasonable protection against harmful interference in a residential installation.

This equipment generates, uses, and can radiate radio frequency energy and, if not installed and used in accordance with the instructions, may cause harmful interference to radio communications.

However, there is no guarantee that interference will not occur in a particular installation. If this equipment does cause harmful interference to radio or television reception, which can be determined by turning the equipment off and on, the user is encouraged to try to correct the interference by one or more of the following measures:

- Reorient or relocate the receiving antenna.
- Increase the separation between the equipment and receiver.
- Connect the equipment into an outlet on a circuit different from that to which the receiver is connected.
- Consult the dealer or an experienced radio/TV technician for help.

Changes or modifications made to this equipment, not expressly approved by Toshiba, or parties authorized by Toshiba, could void the user's authority to operate the equipment.

The instructions shall state that an ALL-POLE MAINS SWITCH with a contact separation of at least 3 mm in each pole shall be incorporated in the electrical installation of the building.

**CAUTION:** These servicing instructions are for use by qualified service personnel only. To reduce the risk of electric shock do not perform any servicing other than that contained in the operating instructions unless you are qualified to do so.

In the spaces provided below, record the Model and Serial No. located on the rear panel of your DVD video player.

Model No. \_\_\_\_\_

Serial No. \_\_\_\_\_

Retain this information for future reference.

Location of the required label

MANUFACTURED

SERIAL NO.

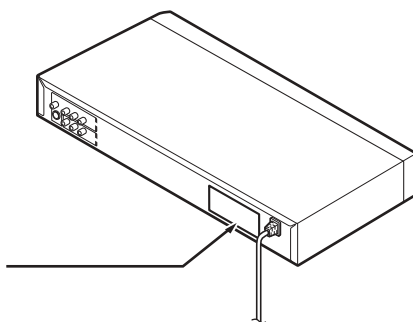

Be aware that this equipment is still powered even after the ON/STANDBY indicator turns off (standby mode) by pressing the ON/STANDBY button. To disconnect this equipment completely from the mains power, pull out the power plug from the wall outlet.

# IMPORTANT SAFETY INSTRUCTIONS

---

**CAUTION:** PLEASE READ AND OBSERVE ALL WARNINGS AND INSTRUCTIONS GIVEN IN THIS OWNER'S MANUAL AND THOSE MARKED ON THE UNIT. RETAIN THIS BOOKLET FOR FUTURE REFERENCE.

This set has been designed and manufactured to assure personal safety. Improper use can result in electric shock or fire hazard. The safeguards incorporated in this unit will protect you if you observe the following procedures for installation, use and servicing. This unit is fully transistorized and does not contain any parts that can be repaired by the user.

**DO NOT REMOVE THE CABINET COVER, OR YOU MAY BE EXPOSED TO DANGEROUS VOLTAGE. REFER SERVICING TO QUALIFIED SERVICE PERSONNEL ONLY.**

1. Read these instructions.
2. Keep these instructions.
3. Heed all warnings.
4. Follow all instructions.
5. Do not use this apparatus near water.
6. Clean only with dry cloth.

7. Do not block any ventilation openings. Install in accordance with the manufacturer's instructions.
  
8. Do not install near any heat sources such as radiators, heat registers, stoves, or other apparatus (including amplifiers) that produce heat.
  
9. Do not defeat the safety purpose of the polarized or grounding-type plug. A polarized plug has two blades with one wider than the other. A grounding type plug has two blades and a third grounding prong. The wide blade or the third prong are provided for your safety. If the provided plug does not fit into your outlet, consult an electrician for replacement of the obsolete outlet.
  
10. Protect the power cord from being walked on or pinched particularly at plugs, convenience receptacles, and the point where they exit from the apparatus.
  
11. Only use attachments/accessories specified by the manufacturer.
  
12. Use only with the cart, stand, tripod, bracket, or table specified by the manufacturer, or sold with the apparatus. When a cart is used, use caution when moving the cart/apparatus combination to avoid injury from tip-over.



# IMPORTANT SAFETY INSTRUCTIONS

---

13. Unplug this apparatus during lightning storms or when unused for long periods of time.
  
  
  
  
  
  
  
  
  
  
14. Refer all servicing to qualified service personnel. Servicing is required when the apparatus has been damaged in any way, such as power-supply cord or plug is damaged, liquid has been spilled or objects have fallen into the apparatus, the apparatus has been exposed to rain or moisture, does not operate normally, or has been dropped.

## ADDITIONAL SAFETY INSTRUCTIONS

---

15. When you use headphones, keep the volume at a moderate level. If you use the headphones continuously with high volume sound, it may cause hearing damage.
  
  
  
  
  
  
  
  
  
  
16. Do not overload wall outlets; extension cords, or integral convenience receptacles as this can result in a risk of fire or electric shock.
  
  
  
  
  
  
  
  
  
  
17. Apparatus shall not be exposed to dripping or splashing and no objects filled with liquids, such as vases, shall be placed on the apparatus.

18. Keep your fingers well clear of the disc tray as it is closing. Neglecting to do so may cause serious personal injury.
  
19. Do not place a heavy object on or step on the apparatus. The object may fall, causing serious personal injury and serious damage to the apparatus.
  
20. Do not use a cracked, deformed, or repaired disc. These discs are easily broken and may cause serious personal injury and apparatus malfunction.
  
21. If the apparatus should smoke or smell, immediately disconnect the power cord from the wall outlet. Wait until the smoke or smell stops, then ask your dealer for a check and repair. Neglecting to do so may cause fire.
  
22. While it is thundering, do not touch the connecting cables or the apparatus.
  
23. The apparatus includes lead, an ingredient of solder used on the PCB, which is a harmful substance to human and the environment. When disposing of this apparatus, follow the rules and regulations in your area.

## Precautions

### Notes on handling

- When shipping the DVD video player, the original shipping carton and packing materials come in handy. For maximum protection, repack the unit as it was originally packed at the factory. Take care not to give it a shock or shake when carrying.
- Do not use volatile liquids, such as insect spray, near the DVD video player. Do not leave rubber or plastic products in contact with the DVD video player for a long time. They will leave marks on the finish.
- The top and rear panels of the DVD video player may become warm after a long period of use. This is not a malfunction.
- When the DVD video player is not in use, be sure to remove the disc and turn off the power.
- If you do not use the DVD video player for a long period, the unit may not function properly in the future. Turn on and use the DVD video player occasionally.

### Notes on locating

- Place the DVD video player on a level surface. Do not use it on a shaky or unstable surface such as a wobbling table or inclined stand. The loaded disc may come off the proper position and cause damage to the DVD video player.
- When you place this DVD video player near a TV, radio, or VCR, the playback picture may become poor and the sound may be distorted. In this case, place the DVD video player away from the TV, radio, or VCR.

### Notes on cleaning

Use a soft, dry cloth for cleaning.

- For stubborn dirt, soak the cloth in a weak detergent solution, wring well and wipe. Use a dry cloth to wipe it dry.  
Do not use any type of solvent, such as thinner and benzene, as they may damage the surface of the DVD video player.
- If you use a chemical saturated cloth to clean the unit, follow that product's instructions.

### To obtain a clear picture

The DVD video player is a high technology, precision device. If the optical pick-up lens and disc drive parts are dirty or worn down, the picture quality becomes poor. To obtain a clear picture, we recommend regular inspection and maintenance (cleaning or parts replacement) every 1,000 hours of use depending on the operating environment. For details, contact your nearest dealer.

### Notes on moisture condensation

Moisture condensation damages the DVD video player. Please read the following carefully.

Moisture condensation occurs, for example, when you pour a cold drink into a glass on a warm day. Drops of water form on the outside of the glass. In the same way, moisture may condense on the optical pick-up lens inside this unit, one of the most crucial internal parts of the DVD video player.

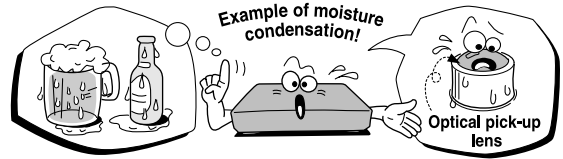

- Moisture condensation occurs during the following cases.
  - When you bring the DVD video player directly from a cold place to a warm place.
  - When you use the DVD video player in a room where you just turned on the heater, or a place where the cold wind from the air conditioner directly hits the unit.
  - In summer, when you use the DVD video player in a hot and humid place just after you move the unit from an air conditioned room.
  - When you use the DVD video player in a humid place.

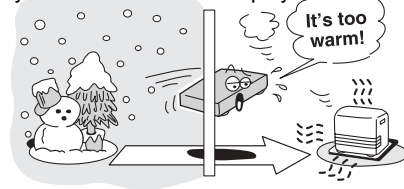

- Do not use the DVD video player when moisture condensation may occur.

If you use the DVD video player in such a situation, it may damage discs and internal parts. Remove the disc, connect the power cord of the DVD video player to the wall outlet, turn on the DVD video player, and leave it for two or three hours. After two or three hours, the DVD video player will have warmed up and evaporated any moisture. Keep the DVD video player connected to the wall outlet and moisture condensation will seldom occur.

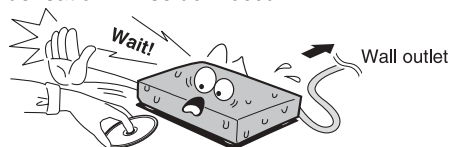



# Notes on Discs

## On handling discs

- Do not touch the playback side of the disc.

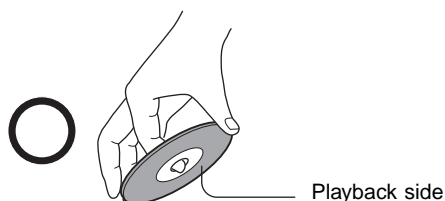

- Do not attach paper or tape to discs.



## On cleaning discs

- Fingerprints and dust on the disc cause picture and sound deterioration. Wipe the disc from the center outwards with a soft cloth. Always keep the disc clean.

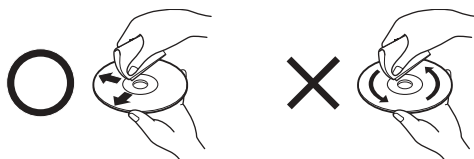

- If you cannot wipe off the dust with a soft cloth, wipe the disc lightly with a slightly moistened soft cloth and finish with a dry cloth.
- Do not use any type of solvent such as thinner, benzene, commercially available cleaners or antistatic spray for vinyl LPs. It may damage the disc.

## On storing discs

- Do not store discs in a place subject to direct sunlight or near heat sources.
- Do not store discs in places subject to moisture and dust such as a bathroom or near a humidifier.
- Store discs vertically in a case. Stacking or placing objects on discs outside of their case may cause warping.

## Structure of disc contents

Normally, DVD video discs are divided into titles, and the titles are sub-divided into chapters. VIDEO CDs and audio CDs are divided into tracks.

DVD video disc

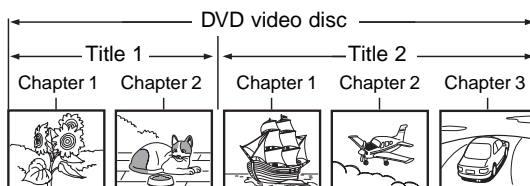

VIDEO CD/audio CD

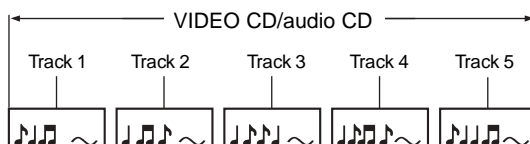

Each title, chapter or track is assigned a number, which is called "title number", "chapter number" or "track number" respectively.

There may be discs that do not have these numbers.

## Notes on copyright

It is forbidden by law to copy, broadcast, show, broadcast on cable, play in public, and rent copyrighted material without permission.

DVD video discs are copy protected, and any recordings made from these discs will be distorted.

This product incorporates copyright protection technology that is protected by method claims of certain U.S. patents and other intellectual property rights owned by Macrovision Corporation and other rights owners. Use of this copyright protection technology must be authorized by Macrovision Corporation, and is intended for home and other limited viewing uses only unless otherwise authorized by Macrovision Corporation. Reverse engineering or disassembly is prohibited.



## Notes on Discs (continued)

### About this owner's manual

This owner's manual explains the basic instructions of this DVD video player. Some DVD video discs are produced in a manner that allows specific or limited operation during playback. As such, the DVD video player may not respond to all operating commands. This is not a defect in the DVD video player. Refer to instruction notes of discs.

"S" may appear on the TV screen during operation. A "⊘" means that the operation is not permitted by the DVD video player or the disc.

### Notes on region numbers

The region number of this DVD video player is 1. If region numbers, which stand for their playable area, are printed on your DVD video disc and you do not find  or , disc playback will not be allowed by the player. (In this case, the DVD video player will display a message on-screen.)



### On VIDEO CDs

This DVD video player supports VIDEO CDs equipped with the PBC (Version 2.0) function. (PBC is the abbreviation of Playback Control.) You can enjoy two playback variations depending on types of discs.

- VIDEO CD not equipped with PBC function (Version 1.1)  
Sound and movie can be played on this DVD video player in the same way as an audio CD.
- VIDEO CD equipped with PBC function (Version 2.0)  
In addition to operation of a VIDEO CD not equipped with the PBC function, you can enjoy playback of interactive software with search function by using the menu displayed on the TV screen (Menu Playback). Some of the functions described in this owner's manual may not work with some discs.

### Playable discs

This DVD video player can play the following discs.

	Disc Mark	Contents	Disc Size	Maximum playback time
DVD video discs		Audio + video (moving pictures)	12 cm	Approx. 4 hours (single sided disc)
				Approx. 8 hours (double sided disc)
			8 cm	Approx. 80 minutes (single sided disc)
				Approx. 160 minutes (double sided disc)
VIDEO CDs		Audio + video (moving pictures)	12 cm	Approx. 74 minutes
			8 cm	Approx. 20 minutes
Audio CDs		Audio	12 cm	Approx. 74 minutes
			8 cm (CD single)	Approx. 20 minutes
<p>The following discs are also available.</p> <ul style="list-style-type: none"> <li>● DVD-R discs of DVD video format</li> <li>● CD-R/CD-RW discs of CD-DA format</li> </ul> <p>Some of these discs may be incompatible.</p>				

- You cannot play discs other than those listed above.
- You cannot play DVD-RAM discs or non-standardized discs, etc., even if they may be labeled as above.
- This DVD video player uses the NTSC color system, and cannot play DVD video discs recorded in any other color system (PAL, SECAM, etc.).

Because of problems and errors that can occur during the creation of DVD software and/or the manufacture of DVD discs, Toshiba America Consumer Products, Inc., Toshiba Hawaii, Inc. and Toshiba of Canada, Ltd. cannot guarantee that this player will play every feature of every DVD bearing the DVD logo. As one of the creators of DVD technology, Toshiba DVD players are manufactured to the highest standards of quality and, as a result, such incompatibilities are very rare. If you happen to experience and difficulty playing a DVD on a Toshiba DVD player, please feel free to call our Contact listed in "How to Obtain Warranty Services" **74**.

# Table of Contents

## Introduction

● SAFETY PRECAUTIONS .....	2
● IMPORTANT SAFETY INSTRUCTIONS ....	4
● Precautions .....	8
● Notes on Discs .....	9
Notes on region numbers .....	10
● Table of Contents .....	11
● Identification of Controls .....	12
Front panel .....	12
Rear panel .....	13
Remote control .....	14
Loading batteries .....	15
Operating with the remote control .....	15

## Connections

● Connecting to a TV .....	18
Connecting to a TV .....	18
Connecting to an audio system and TV equipped with component video inputs .....	19
● Connecting to Optional Equipment .....	20
Connecting to an amplifier equipped with a Dolby Digital decoder .....	21
Connecting to an amplifier equipped with Dolby Surround Pro Logic .....	21
Connecting to an amplifier equipped with a DTS decoder .....	22
Connecting to an amplifier equipped with an MPEG2 audio decoder .....	22
Connecting to an amplifier equipped with a digital audio input .....	23

## Basic playback

● Playing a Disc .....	26
Basic playback .....	26
● Variable Speed Playback .....	28
Playing in fast reverse or fast forward directions .....	28
Playing frame by frame .....	28
Playing in slow-motion .....	29
Resuming playback from the same location ..	29
● Locating a Desired Section .....	30
Locating a title using the top menu .....	30
Locating a desired section by entering the corresponding number .....	31
Locating a specific chapter or track .....	31

## Advanced playback

● Accessing a Specific Location Directly .....	34
Entering the time counter of the desired location .....	34
● Repeating a Specific Segment .....	34
Repeating a specific segment .....	34
● Playing in a Varied Order .....	35
Playing titles, chapters or tracks in a varied order .....	35
● Playing in a Favorite Order .....	36
Setting titles, chapters, or tracks in a favorite order .....	36
● Zooming a Picture .....	37
Zooming a picture .....	37
● Selecting the Picture Enhancement (E.P.M.) .....	38
Selecting the picture enhancement .....	38
● Selecting the Sound Enhancement (E.A.M.) .....	39
Selecting the sound enhancement .....	39
● Selecting the Camera Angle .....	40
Changing the camera angle .....	40
● Selecting Subtitles .....	41
Selecting a subtitle language .....	41
● Selecting a Language .....	42
Selecting a playback audio setting .....	42
● On-screen Display Operation .....	44
On-screen display operation .....	44
● Playing MP3/WMA Files .....	48
Playing MP3/WMA files .....	48
● Viewing JPEG Files .....	50
Starting from a thumbnail view .....	50
Viewing a single image .....	53
Playing slide show .....	55
Selecting a folder .....	56

## Function setup

● Customizing the Function Settings .....	60
Setting procedure .....	60
Setting details .....	62
● Table of Languages .....	70

## Others

● Before Calling Service Personnel .....	72
● Specifications .....	73
● LIMITED WARRANTY DVD VIDEO PLAYER .....	74

# Identification of Controls

See the page in  for details.

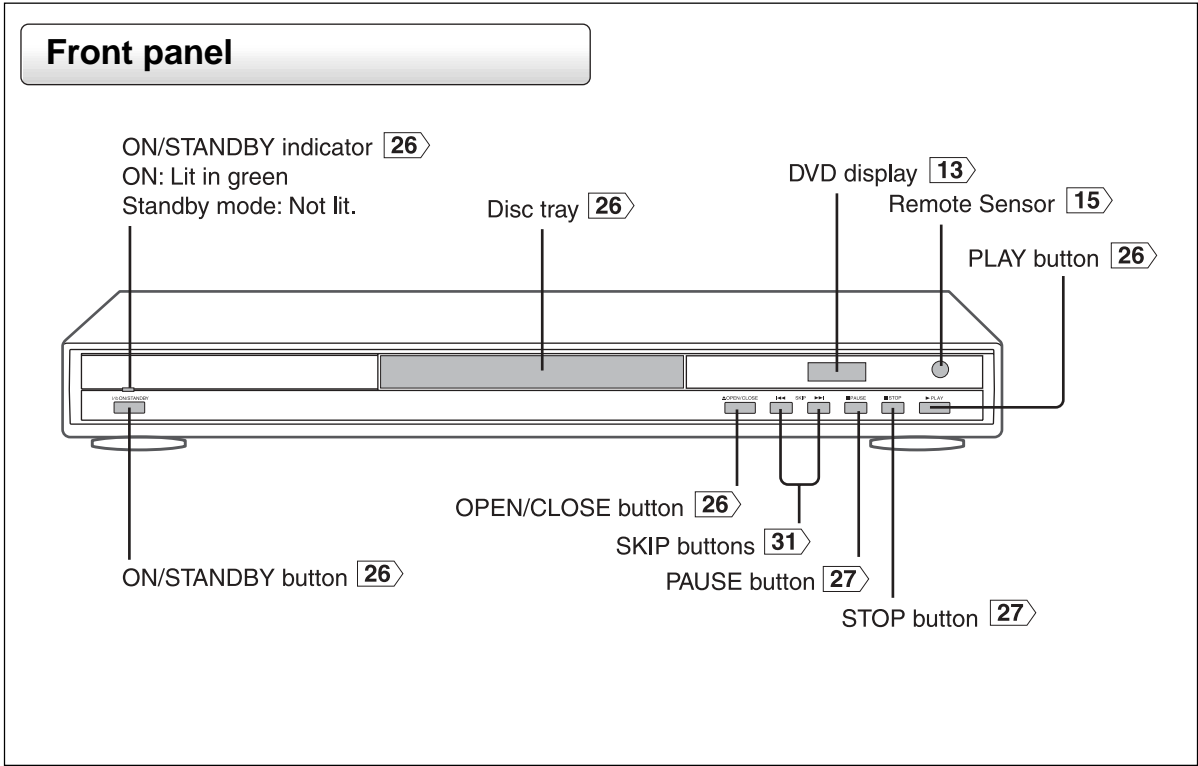

## Rear panel

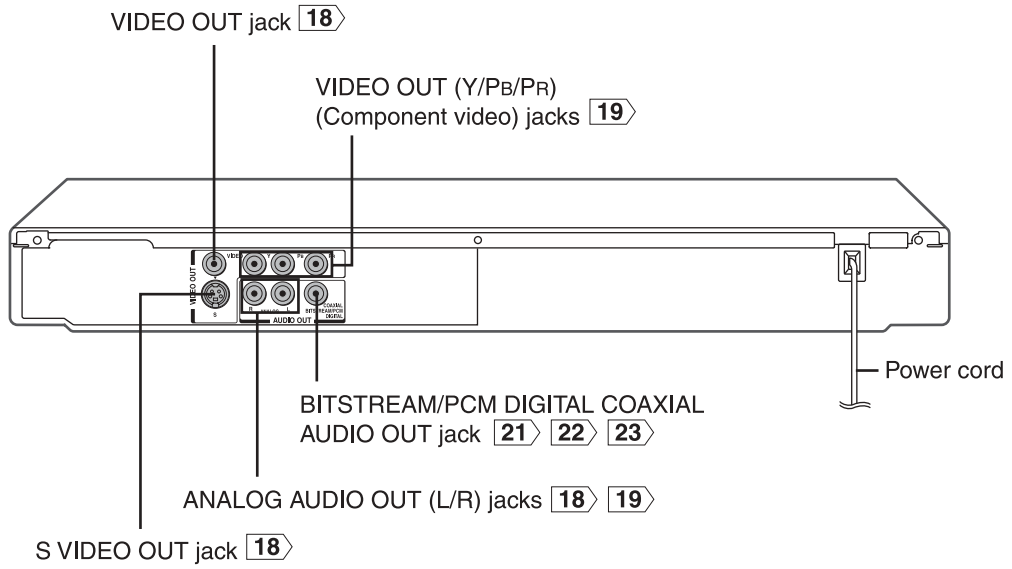

# Identification of Controls (continued)

The instructions in this manual describe the functions on the remote control. See the page in    for details.

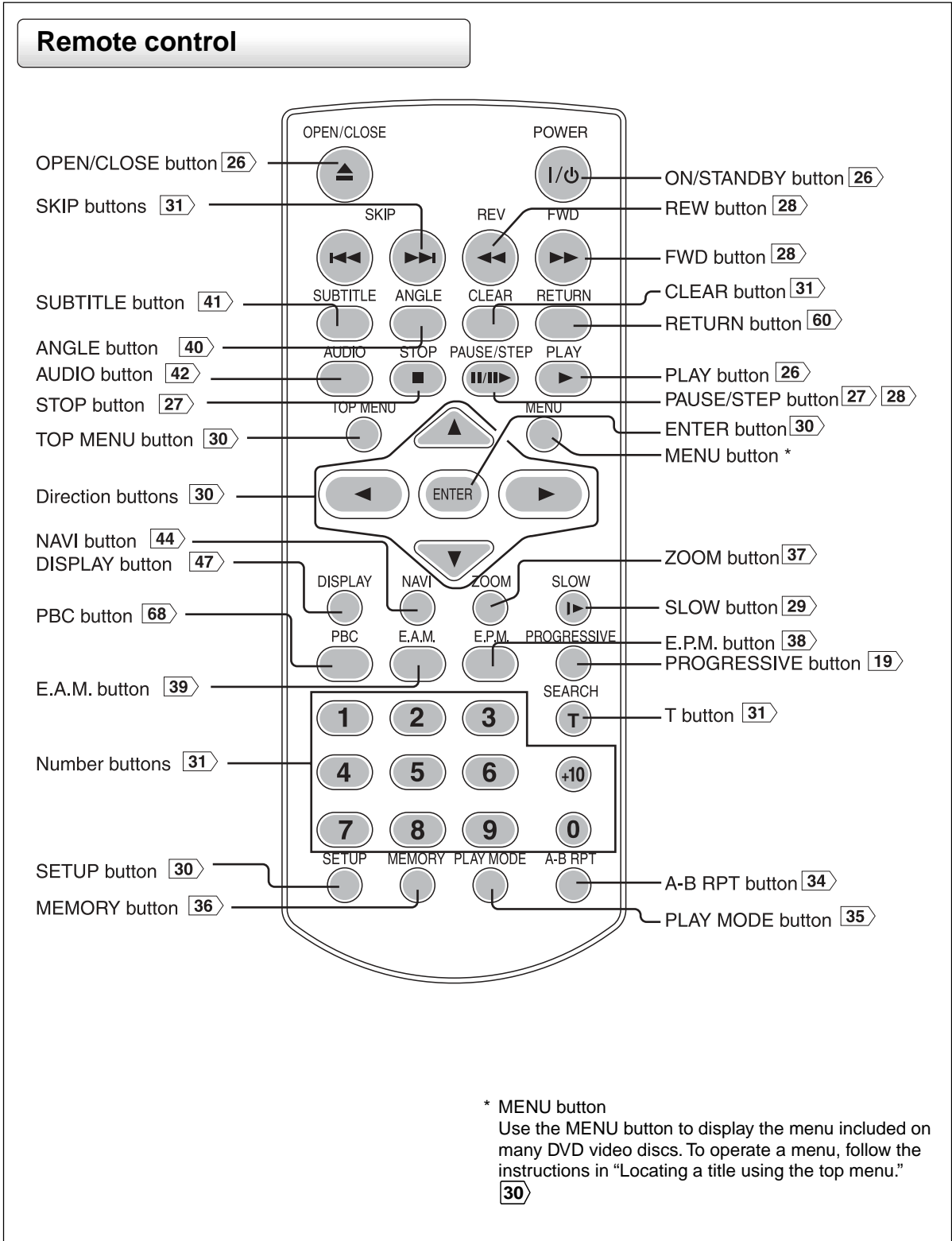

- About the illustrations of the battery compartment  
There are two types of battery compartment in the supplied remote controls. (This does not mean a difference in performance between the two.) Refer to either illustration depending on the actual remote control.

## Loading batteries

- 1** Open the cover.

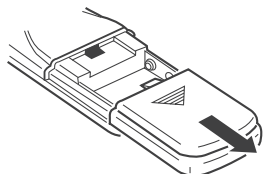

- 2** Insert batteries (AA size).

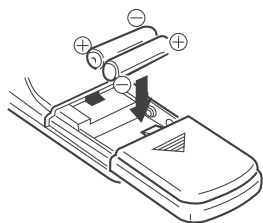

Make sure to match the + and – on the batteries to the marks inside the battery compartment.

- 3** Close the cover.

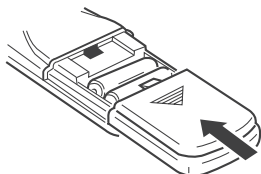

### Notes on batteries

Improper use of batteries may cause battery leakage and corrosion. To operate the remote control correctly, follow the instructions below.

- Do not insert batteries into the remote control in the wrong direction.
- Do not charge, heat, open, or short-circuit the batteries. Do not throw batteries into a fire.
- Do not leave dead or exhausted batteries in the remote control.
- Do not use different types of batteries together, or mix old and new batteries.
- If you do not use the remote control for a long period of time, remove the batteries to avoid possible damage from battery corrosion.
- If the remote control does not function correctly or if the operating range becomes reduced, replace all batteries with new ones.
- If battery leakage occurs, wipe the battery liquid from the battery compartment, then insert new batteries.

## Operating with the remote control

Point the remote control at the remote sensor and press the buttons.

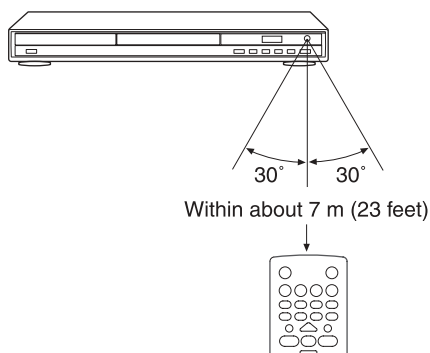

Distance: About 7 m (23 feet) from the front of the remote sensor

Angle: About 30° in each direction of the front of the remote sensor

- \* Do not expose the remote sensor of the DVD video player to a strong light source such as direct sunlight or other illumination. If you do so, you may not be able to operate the DVD video player via the remote control.

### Notes on the remote control

- Direct the remote control at the remote sensor of the DVD video player.
- Do not drop or give the remote control a shock.
- Do not leave the remote control near an extremely hot or humid place.
- Do not spill water or put anything wet on the remote control.
- Do not open the remote control.

# Connections

Read this chapter first to make all necessary preparations.

- Connecting to a TV
- Connecting to an audio system and TV equipped with component video inputs
- Connecting to an amplifier equipped with a Dolby Digital decoder
- Connecting to an amplifier equipped with Dolby Surround Pro Logic
- Connecting to an amplifier equipped with a DTS decoder
- Connecting to an amplifier equipped with an MPEG2 audio decoder
- Connecting to an amplifier equipped with a digital audio input



# Connecting to a TV

Connect the DVD video player to your TV.  
 For details of output sound, see **43**.

## Connecting to a TV

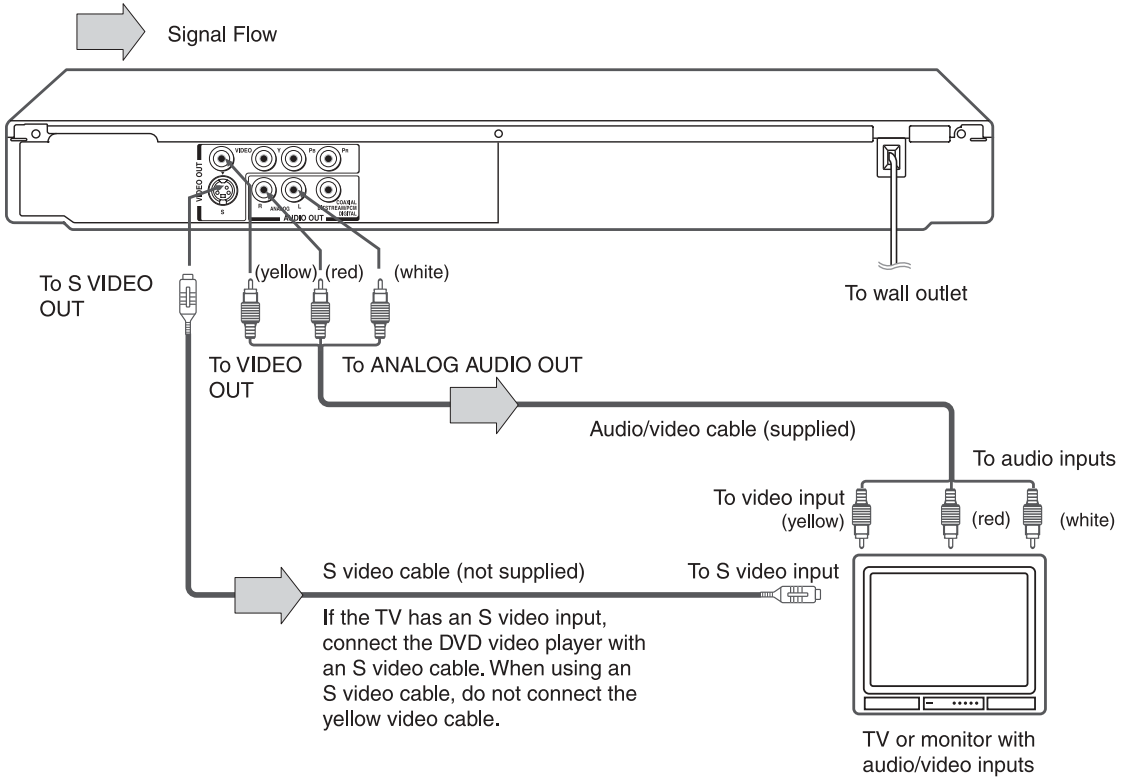

• Make the following setting.

On-screen display	Select:	Page
"Digital Output"	"Bitstream" or "PCM"	<b>60</b> <b>64</b>

Notes

- Refer to the owner's manual of the connected TV as well.
- When you connect the DVD video player to your TV, be sure to turn off the power and unplug both units from the wall outlet before making any connections.
- If your television set has one audio input, connect the left and right audio outputs of the DVD video player to a Y cable adapter (not supplied) and then connect to your TV.
- Connect the DVD video player directly to your TV. If you connect the DVD video player to a VCR, TV/VCR combination or video selector, the playback picture may be distorted as DVD video discs are copy protected.

**Interlaced outputs/inputs (ColorStream®)**  
 Some TVs or monitors are equipped with component video inputs. Connecting to these inputs allows you to enjoy higher quality picture playback. Actual labels for component video inputs may vary depending on the TV manufacturer. (ex. Y, R-Y, B-Y or Y, C<sub>B</sub>, C<sub>R</sub>)  
 In some TVs or monitors, the color levels of the playback picture may be reduced slightly or the tint may change. In such a case, adjust the TV or monitor for optimum performance.

**Progressive outputs/inputs (ColorStream®Pro)**  
 Some TVs or monitors are equipped with component video inputs that are capable of reproducing a progressively scanned video signal. Connecting to these inputs allows you to view the highest quality pictures with less flicker.

## Connecting to an audio system and TV equipped with component video inputs

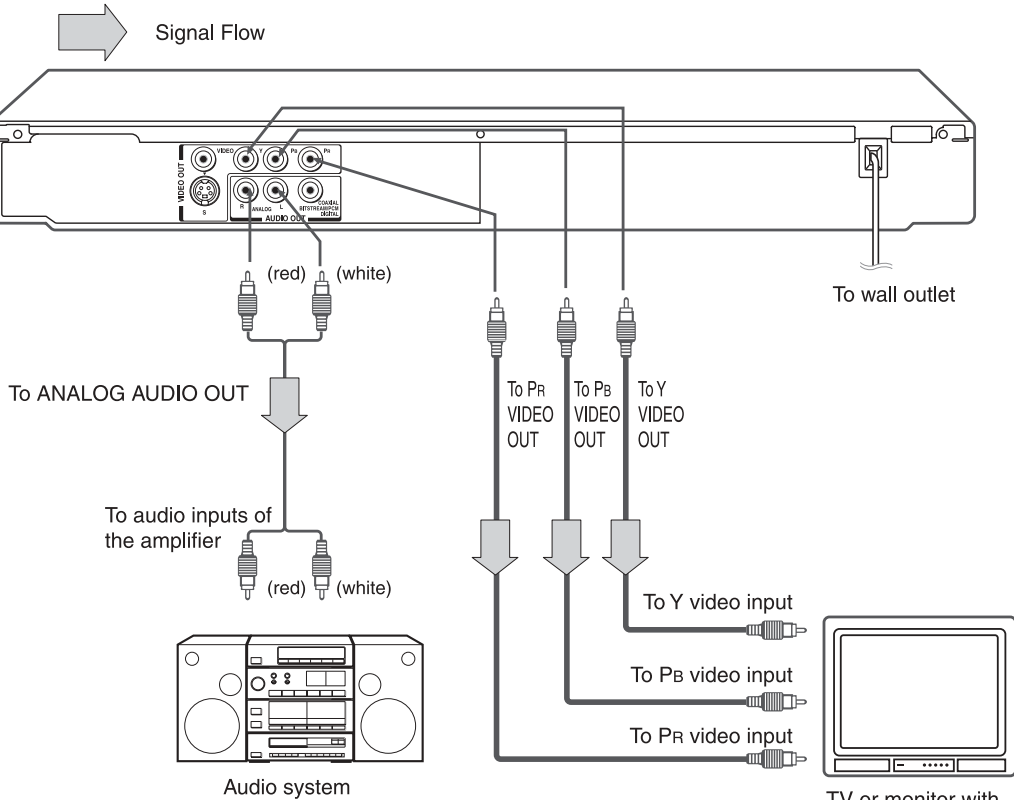

- Switching the output signal (interlaced/progressive) using the remote control (only when "Progressive" is set to "Enable" **62**)  
 You can temporarily switch the output signal for better picture quality. Press PROGRESSIVE on the remote control.

- Make the following setting.

On-screen display	Select:	Page
"Digital Output"	"Bitstream" or "PCM"	<b>60</b> <b>64</b>

If you connect a progressive TV, set "Progressive" to "Enable" **62**.

- Notes**
- Refer to the owner's manual of the connected equipment as well.
  - When you connect the DVD video player to other equipment, be sure to turn off the power and unplug all of the equipment from the wall outlet before making any connections.
  - If you place the DVD video player near a tuner or radio, the radio broadcast sound might be distorted. In this case, place the DVD video player away from the tuner and radio.
  - The output sound of the DVD video player has a wide dynamic range. Be sure to adjust the receiver's volume to a moderate listening level. Otherwise, high volume sound may damage your hearing as well as the speakers.
  - Turn off the amplifier before you connect or disconnect the DVD video player's power cord. If you leave the amplifier power on, the speakers may be damaged.

## Connecting to Optional Equipment

You can enjoy high quality dynamic sounds by connecting the DVD video player to optional audio equipment.

- For connection to your TV, see “Connecting to a TV” [18](#) [19](#).
- For details of output sound, see [43](#).
- This section uses the following reference marks.

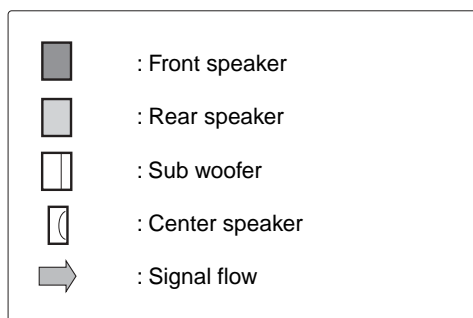

### Notes

- DO NOT connect the BITSTREAM/PCM AUDIO OUT jack of the DVD video player to the AC-3 RF input of a Dolby Digital Receiver. This input on your A/V Receiver is reserved for Laserdisc use only and is incompatible with the BITSTREAM/PCM AUDIO OUT jack of the DVD video player.
- Connect the BITSTREAM/PCM AUDIO OUT jack of the DVD video player to the “DIGITAL (COAXIAL)” input of a Receiver or Processor.
- Refer to the owner’s manual of the connected equipment as well.
- When you connect the DVD video player to other equipment, be sure to turn off the power and unplug all of the equipment from the wall outlet before making any connections.
- The output sound of the DVD video player has a wide dynamic range. Be sure to adjust the receiver’s volume to a moderate listening level. Otherwise, the speakers may be damaged by a sudden high volume sound.
- Turn off the amplifier before you connect or disconnect the DVD video player’s power cord. If you leave the amplifier power on, the speakers may be damaged.

### Warning

- When you are connecting (via the BITSTREAM/PCM AUDIO OUT jack) an AV decoder that does not have Dolby Digital, Digital Theater Systems (DTS) or MPEG2 decoding function, be sure to set “Digital Output” to “PCM” from the on-screen displays [60](#) [64](#). Otherwise, high volume sound may damage your hearing as well as the speakers.
- When playing DTS-encoded discs (audio CDs), excessive noise may be output from the analog audio output jacks. To avoid possible damage to the audio system, you should take proper precautions when the analog audio output jacks of the DVD video player are connected to an amplification system. To enjoy DTS Digital Surround™ playback, an external 5.1 channel DTS Digital Surround™ decoder system must be connected to the BITSTREAM/PCM AUDIO OUT jack of the DVD video player.

## Connecting to an amplifier equipped with a Dolby Digital decoder

### Dolby Digital

Dolby Digital is the surround sound technology used in theaters showing the latest movies, and is now available to reproduce this realistic effect in the home. You can enjoy motion picture and live concert DVD video discs with this dynamic realistic sound by connecting the DVD video player to a 6 channel amplifier equipped with a Dolby Digital decoder or Dolby Digital processor. If you have a Dolby Surround Pro Logic decoder, you will obtain the full benefit of Pro Logic from the same DVD movies that provide full 5.1-channel Dolby Digital soundtracks, as well as from titles with the Dolby Surround mark.

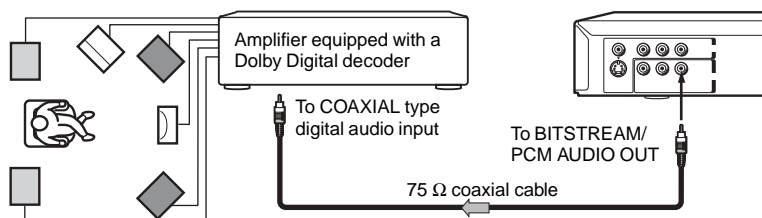

Manufactured under license from Dolby Laboratories. "Dolby", "Pro Logic" and the double-D symbol are trademarks of Dolby Laboratories. Confidential unpublished works. Copyright 1992-1997 Dolby Laboratories. All rights reserved.

- Use DVD video discs encoded via the Dolby Digital recording system.
- Make the following setting.

On-screen display	Select:	Page
"Digital Output"	"Bitstream"	<b>60</b> <b>64</b>
Recording system	D	<b>43</b>

## Connecting to an amplifier equipped with Dolby Surround Pro Logic

### Dolby Surround Pro Logic

You can enjoy the dynamic realistic sound of Dolby Surround Pro Logic by connecting an amplifier and speaker system (right and left front speakers, a center speaker, and one or two rear speakers).

- With an amplifier equipped with Dolby Digital  
Connect the equipment the same way as described in "Connecting to an amplifier equipped with a Dolby Digital decoder." Refer to that amplifier's owner's manual and set the amplifier so you can enjoy Dolby Surround Pro Logic sound.
- With an amplifier not equipped with Dolby Digital  
Connect the equipment as follows.

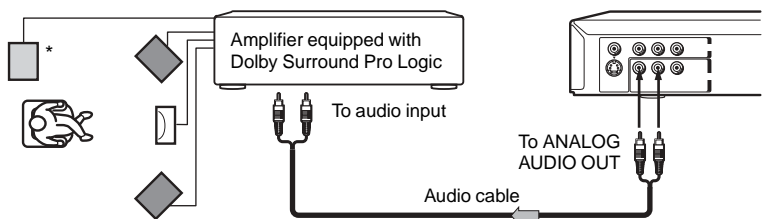

- Make the following setting.

On-screen display	Select:	Page
"Digital Output"	"Bitstream" or "PCM"	<b>60</b> <b>64</b>

\* Connect one or two rear speakers. The output sound from the rear speakers will be monaural even if you connect two rear speakers.

# Connecting to Optional Equipment (Continued)

## Connecting to an amplifier equipped with a DTS decoder

### Digital Theater Systems (DTS)

DTS is a high quality surround technology used in theaters and now available for home use, on DVD video discs or audio CDs.

If you have a DTS decoder or processor, you can obtain the full benefit of 5.1 channel DTS encoded sound tracks on DVD video discs or audio CDs.

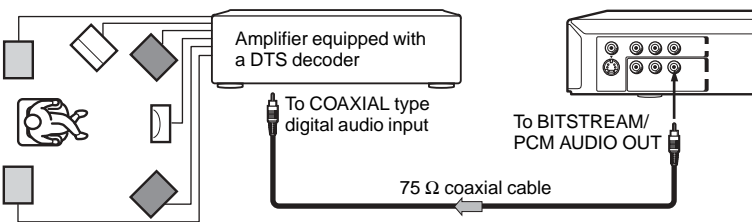

"DTS" and "DTS Digital Out" are trademarks of Digital Theater Systems, Inc.

- Use DVD video discs or audio CDs encoded via the DTS recording system.
- Make the following setting.

On-screen display	Select:	Page
"Digital Output"	"Bitstream" or "PCM"	<b>60</b> <b>64</b>
Recording system	DTS	<b>43</b>

## Connecting to an amplifier equipped with an MPEG2 audio decoder

### MPEG2 sound

You can enjoy motion picture and live concert DVD video discs with dynamic realistic sound by connecting an amplifier equipped with an MPEG2 audio decoder or MPEG2 audio processor.

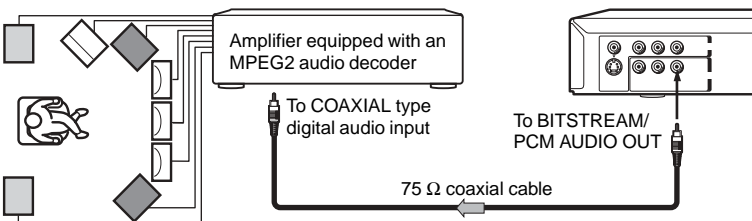

- Use DVD video discs encoded via the MPEG2 recording system.
- Make the following setting.

On-screen display	Select:	Page
"Digital Output"	"Bitstream"	<b>60</b> <b>64</b>
Recording system	MPEG2	<b>43</b>

## Connecting to an amplifier equipped with a digital audio input

### 2 channel digital stereo

You can enjoy the dynamic sound of 2 channel digital stereo by connecting an amplifier equipped with a digital audio input and speaker system (right and left front speakers).

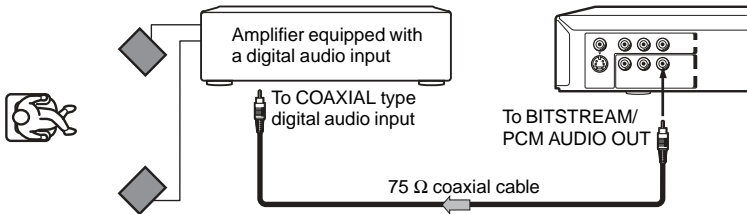

- Make the following setting.

On-screen display	Select:	Page
"Digital Output"	"PCM"	60
		64

# **Basic playback**

Begin your operation.

- Playing a Disc
- Variable Speed Playback
- Locating a Desired Section

## Playing a Disc

This section shows you the basics on how to play a disc.

### CAUTION

Keep your fingers well clear of the disc tray as it is closing. Neglecting to do so may cause serious personal injury.

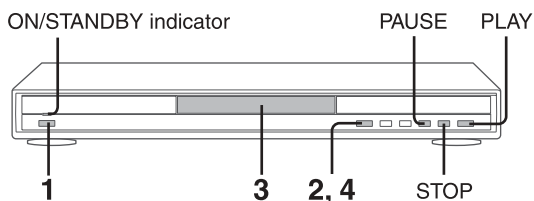

## Basic playback

### Preparations

- When you want to view a disc, turn on the TV and select the video input connected to the DVD video player.
- When you want to enjoy the sound of discs from the audio system, turn on the audio system and select the input connected to the DVD video player.

### 1 Press the ON/STANDBY button.

POWER



The DVD video player turns on. The ON/STANDBY indicator on the player illuminates.

When the DVD video player is turned on for the first time, a message appears. Press ENTER, and make the proper settings before proceeding to step 2. **[69]**

### 2 Press OPEN/CLOSE.

OPEN/CLOSE



The disc tray opens.

### 3 Place the disc on the disc tray.

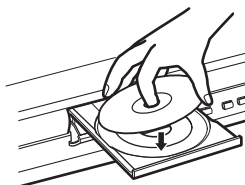

With the playback side down

- There are two different disc sizes. Place the disc in the correct guide on the disc tray. If the disc is out of the guide, it may damage the disc and cause the DVD video player to malfunction.
- Do not place a disc which is unplayable in this DVD video player.

### 4 Press OPEN/CLOSE to close the disc tray. Playback starts.

OPEN/CLOSE



If you insert a DVD video disc that contains a top menu, a menu may appear. See "Locating a title using the top menu." **[30]**

- You may need to press the TOP MENU or MENU button to display disc menu (depending on the actual DVD video disc.)

### Note

For resuming playback, see .

### ■ To start playback in the stop mode

Press PLAY.

PLAY





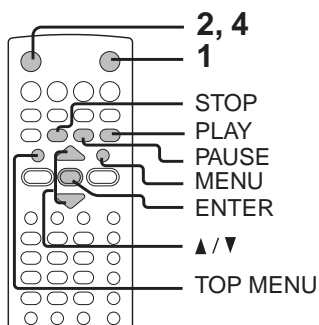

■ To obtain a higher quality picture

Occasionally, some picture noise not usually visible during a normal broadcast may appear on the TV screen while playing a DVD video disc because the high resolution pictures on these discs include a lot of information. While the amount of noise depends on the TV you use with this DVD video player, you should generally reduce the sharpness adjustment on your TV when viewing DVD video discs.

■ About

The icons on the heading bar show the playable discs for the function described under that heading.

: You can use this function with DVD video discs.

: You can use this function with VIDEO CDs.

: You can use this function with audio CDs.

■ To pause playback (still mode)

Press PAUSE/STEP during playback.



To resume normal playback, press the PLAY button.

- The sound is muted during still mode.

■ To stop playback

Press STOP.



■ To remove the disc

Press OPEN/CLOSE.



Remove the disc after the disc tray opens completely.

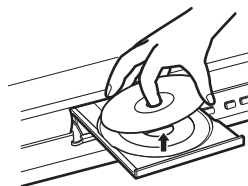

Be sure to press the OPEN/CLOSE button to close the disc tray after you remove the disc.

■ To turn the power off (To enter the standby mode)

Press ON/STANDBY to turn the ON/STANDBY indicator off.

Note

Be aware that this equipment is still powered even after the ON/STANDBY indicator turns off (standby mode) by pressing the ON/STANDBY button. To disconnect this equipment completely from the mains power, pull out the power plug from the wall outlet.

■ About the screen saver

If you pause a picture of a DVD video disc and leave it still for a long while, the screen saver of the DVD video player automatically appears (when "Screen Saver" is set to "On" **[66]**). To turn off the screen saver, press the PLAY button.

■ Automatic Power Off function

If the DVD video player is stopped, or the screen saver is engaged for approximately 20 minutes, the DVD video player will automatically turn itself off.

Notes

- Do not move the DVD video player during playback. Doing so may damage the disc.
- Use the OPEN/CLOSE button to open and close the disc tray. Do not push the disc tray while it is moving. Doing so may cause the DVD video player to malfunction.
- Do not push up on the disc tray or put any objects other than discs on the disc tray. Doing so may cause the DVD video player to malfunction.
- In many instances, a menu screen will appear after playback of a movie is completed. Prolonged display of an on-screen menu may damage your television set, permanently etching that image onto its screen. To avoid this, be sure to press the STOP button on your remote control once the movie is completed.

# Variable Speed Playback

You can play discs at various speeds, and resume playback from the location where you stopped playback.

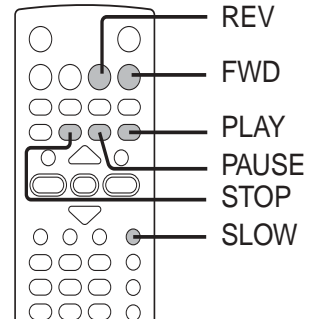

## DVD VCD CD Playing in fast reverse or fast forward directions

Press REV or FWD during playback.

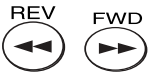

REV: Fast reverse playback  
FWD: Fast forward playback

Each time you press the REV or FWD button, the playback speed changes.

■ To resume normal playback

Press PLAY.



Notes

- The DVD video player mutes sound and subtitles during reverse and forward scan of DVD video discs. However, the DVD video player plays sound during fast forward or fast reverse play of audio CDs.
- The playback speed may differ depending on the disc.

## DVD VCD Playing frame by frame

Press PAUSE/STEP during still playback.



Each time you press the PAUSE/STEP button, the picture advances one frame.

■ To resume normal playback

Press PLAY.



Note

The sound is muted during frame by frame playback.

## Playing in slow-motion

Press SLOW during playback.



Each time you press the SLOW button, the slow-motion speed changes.

■ To resume normal playback

Press PLAY.



Note

The sound is muted during slow-motion playback.

## Resuming playback from the same location

**1** Press STOP at the location where you want to interrupt playback.



The DVD video player memorizes the location where playback is stopped.

**2** Press PLAY.



The DVD video player resumes playback from the location where you stopped playback.

■ To start playback from the beginning regardless of the location where you stopped playback

1 Press STOP twice.



The DVD video player deletes the memory of the location.

2 Press PLAY.



 Playback starts from the beginning of the current title.

 Playback starts from the beginning of the disc.

- If you want to return to the beginning of a DVD video disc, open and close the disc tray once with the OPEN/CLOSE button before pressing the PLAY button.

Notes

- Resuming cannot function when:
  - you change the parental lock setting **[67]** or select a disc menu language **[65]**.
  - you play a PBC-featured VIDEO CD while “PBC” **[68]** is set to “On”.
  - you open the disc tray.
  - you disconnect the power plug of the DVD video player.
- There may be a difference in the location where playback resumes depending on the disc.
- Settings you changed using the on-screen displays while the DVD video player keeps a location in the memory may function only after the memory is cleared.

# Locating a Desired Section

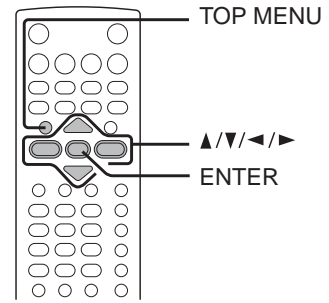

Normally, DVD video discs are divided into titles, and the titles are sub-divided into chapters. VIDEO CDs and audio CDs are divided into tracks. You can quickly locate any specific title, chapter, or track.

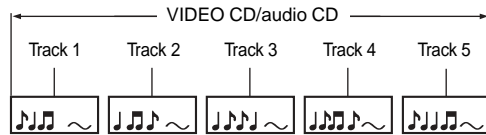
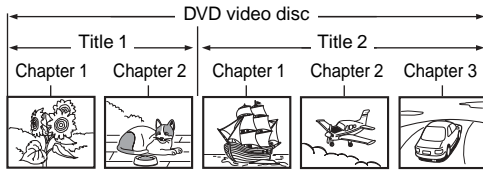

## DVD Locating a title using the top menu

**1** Press TOP MENU.



The top menu appears on the TV screen.

e.g.

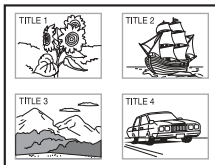

**2** Press ▲/▼/◀/▶ to select the title you want.

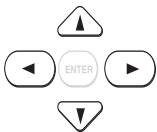

If the titles in the top menu are assigned a number, you can directly locate a specific title by pressing its designated number with the number buttons.

**3** Press ENTER.



Playback starts from chapter 1 of the selected title.

### Notes

- The instructions above describe basic procedures which may vary depending on the contents of the DVD video disc. If different instructions appear on the TV screen, follow those instructions.
- If you display the top menu during playback and press the TOP MENU button again without selecting any title, the DVD video player may resume playback from the point where you first pressed the TOP MENU button (depending on the actual DVD video disc.)
- This method of locating a title is available only on a disc that contains a top menu.
- Instruction notes of discs may refer to the button that displays the top menu as TITLE button.

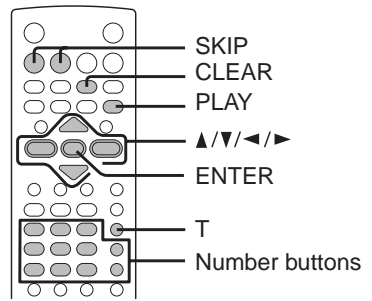

**DVD VCD CD Locating a desired section by entering the corresponding number**

**1** Press T.

If you are using a VIDEO CD/audio CD, skip step 2. Then at step 3, enter the number for the track you want using the number buttons.

SEARCH T e.g.

**2** Press ◀/▶ to select a section you want to locate.

e.g. When you want to locate a chapter.

**3** Press ▲/▼ to enter a number of the section.

Also the number buttons are available.

e.g. To enter 25

**4** Repeat steps 2 and 3 if necessary.

**5** Press PLAY or ENTER.

Playback starts from the selected section.

- Notes
- Pressing the CLEAR button resets the numbers. To clear the display, press the T button several times.
  - This method of locating a title is available only on a disc that contains title numbers.

**DVD VCD CD Locating a specific chapter or track**

Press SKIP ◀◀ or ▶▶ repeatedly to access the chapter or track number you want.

Playback starts from the selected chapter or track.

To locate succeeding chapters or tracks.

Playback starts from the beginning of the current chapter or track. When you press twice, playback starts from the beginning of the preceding chapter or track.

- Notes
- Some titles may not display chapter numbers.
  - If you press and hold the SKIP ◀◀ or ▶▶ button on the front panel during playback, the DVD video player performs fast reverse or fast forward playback. You can vary the speed by pressing the button repeatedly. To locate chapters or tracks during fast reverse or fast forward playback, first press the PLAY button to resume normal playback, then use the SKIP ◀◀ or ▶▶ button.
  - When you set "Title Stop" to "Off" [68], you can access chapters in another title. If you go back to the preceding title by pressing the SKIP ◀◀ button, the DVD video player locates the first chapter of the title. When "Title Stop" is set to "On," you can access chapters only within the current title.

Basic playback



# Advanced playback

Customizing the performance of your DVD video player.

- Accessing a Specific Location Directly
- Repeating a Specific Segment
- Playing in a Varied Order
- Playing in a Favorite Order
- Zooming a Picture
- Selecting the Picture Enhancement (E.P.M.)
- Selecting the Sound Enhancement (E.A.M.)
- Selecting the Camera Angle
- Selecting Subtitles
- Selecting a Language
- On-screen Display Operation
- Playing MP3/WMA Files
- Viewing JPEG Files

## Accessing a Specific Location Directly

You can access a specific location by entering its corresponding time (hours, minutes, seconds).

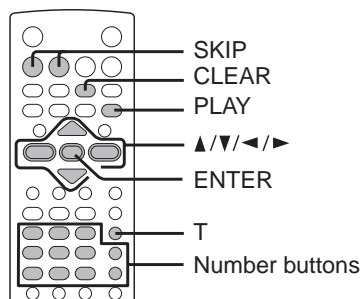

### DVD VCD CD Entering the time counter of the desired location

**1** Press T several times.



You may have to press further depending on the disc. Press the button repeatedly until the time counter is highlighted.

e.g.



**2** Press the number buttons to enter the time.

e.g.



**3** Press PLAY or ENTER.

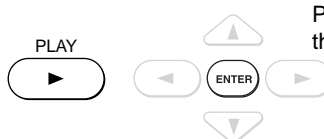

Playback starts from the desired location.

**Notes**

- Some discs may not respond to this process.
- Some scenes may not be located precisely as you specified.
- This method for accessing specific locations is available only within the current title of the DVD video disc or within the current track of the VIDEO CD/audio CD.

## Repeating a Specific Segment

You can specify a desired segment and repeat it.

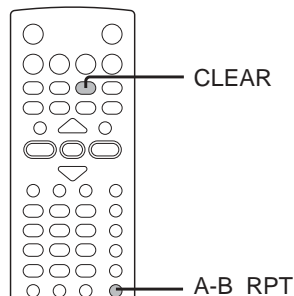

### DVD VCD CD Repeating a specific segment

**1** Press A-B RPT at the beginning of the segment (point A) you want to play repeatedly.

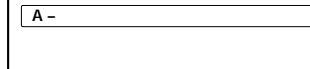

**2** Press A-B RPT again at the end of the segment (point B).



The DVD video player automatically returns to point A and starts repeat playback of the selected segment (A-B).

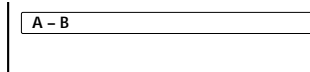

■ To resume normal playback

Press CLEAR or A-B RPT.

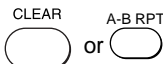

**Notes**

- Some discs may not permit A-B repeat operation.
- You cannot set the A-B repeat function for a segment that includes multiple camera angles **40**.
- You can specify a segment only within the current title or track (VIDEO CD).
- There may be a slight difference between point A and the location where playback actually resumes depending on the disc.



# Playing in a Varied Order

You can play titles, chapters within a title, or tracks in a varied order.

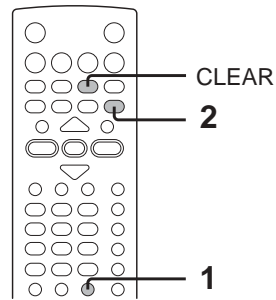

## Playing titles, chapters or tracks in a varied order

### 1 Press PLAY MODE.



Each time you press the PLAY MODE button, the playback mode changes as follows.

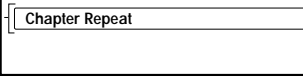

e.g.

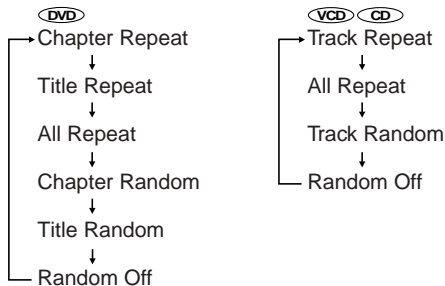

- Chapter Repeat:**  
Repeats the current chapter.
- Title Repeat:**  
Repeats the current title.
- Track Repeat:**  
Repeats the current track.
- All Repeat:**  
Repeats the entire disc.
- Chapter Random:**  
Plays the chapters within the current title in random order.
- Title Random:**  
Plays the titles in random order.
- Track Random:**  
Plays the tracks in random order.
- Random Off (Repeat Off):**  
Resumes normal playback.

If you press the PLAY MODE button during playback, the DVD video player automatically enters the selected playback mode after finishing the current title, chapter or track.

### 2 Press PLAY.



The DVD video player starts playback in the selected mode. Press the PLAY button within about 5 seconds after you press the PLAY MODE button.

- To resume normal playback  
Press CLEAR.



**Note**  
Some discs may not permit these operations.

## Playing in a Favorite Order

You can combine your favorite titles, chapters, or tracks and play them in the order you determine. You can program up to 30 selections into the memory. (Memory playback)

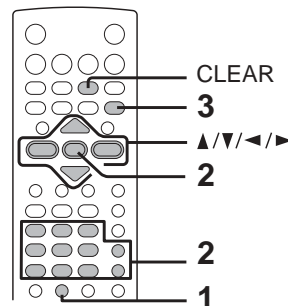

### DVD VCD CD Setting titles, chapters, or tracks in a favorite order

**1** Insert a disc and press MEMORY during stop.



The following display appears.

e.g.

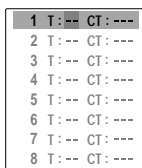

T: Title number  
CT: Chapter number  
or track number

**2** Select the items in the order you want by pressing the number buttons, then ENTER for each item.

Each time you press the ◀/▶ button, the space of "T" and "CT" is highlighted in turn. Highlight where you want to enter, then press the corresponding number buttons.

To select another chapter in the same title, you do not need to select the title number.

To select tracks from a VIDEO CD/audio CD in order, press the number buttons for the track, then press the ENTER button for each selection you want.

**3** Press PLAY while the display appears on the TV screen.



The DVD video player starts memory playback.

■ To change the programmed selections

- 1 While the display appears on the TV screen, press ▲/▼/◀/▶ to move the highlighted bar to the item you want to change.
- 2 Change the selection following the instructions in step 2.

■ To cancel the programmed selections

- 1 While the display appears on the TV screen, press ▲/▼ to move the highlighted bar to the item you want to cancel.
- 2 Press CLEAR.

■ To resume normal playback from memory playback Press CLEAR.



The memory playback indicator disappears.

■ To program during playback

If you press the MEMORY button during playback, a programming display appears. Follow steps 2 and 3.

#### Notes

- Some discs may not permit memory playback operation.
- If you press the PLAY MODE button during memory playback, the DVD video player repeats the current memory playback.
- If you press the MEMORY or RETURN button while the display appears on the TV screen, the display disappears.
- The programmed selections will be cleared when you turn off the DVD video player.

# Zooming a Picture

You can magnify areas within a picture.

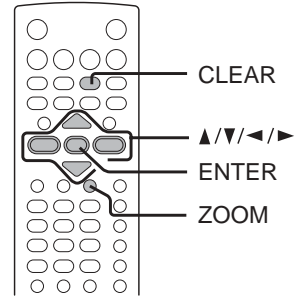
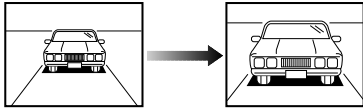

## DVD VCD Zooming a picture

Press ZOOM during normal, slow or still playback.



The DVD video player enters the zoom playback mode and displays the icon.

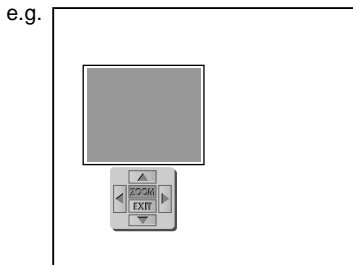

**ZOOM** : As you repeatedly press the ENTER (or ZOOM) button while "ZOOM" is selected, the magnification level changes. Variation of the levels includes image reduction.

**EXIT** : If you press the ENTER button while "EXIT" is highlighted, you can turn off the icon, keeping the current magnification level.

You can shift the highlight within the icon by the ▲ / ▼ / ◀ / ▶ buttons.

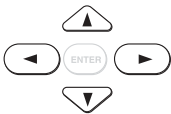

If you press and hold the ▲ / ▼ / ◀ / ▶ buttons, the zoom point shifts.



Pressing the CLEAR button restores the zoom point to the center of the picture.

### ■ To resume normal playback

While "ZOOM" is selected, press ZOOM repeatedly to turn off the icon. Original picture is restored when the icon disappears.



- The ENTER button cannot cancel zoom playback if you have turned off the icon by selecting "EXIT." To restore normal picture size, press the ZOOM button to display the icon, then further press the ZOOM button until the icon turns off.

### Notes

- Some discs may not respond to zoom feature.
- During some scenes, the buttons may not work as described.
- Zooming does not work on subtitles or menus included on DVD video discs.
- While the icon is displayed, the ▲ / ▼ / ◀ / ▶ buttons cannot work on menus included on the DVD video discs. If you want to view the menus, turn off the icon.
- The magnification level varies depending on the picture size you select. **62**

# Selecting the Picture Enhancement (E.P.M.\*)

You can easily select a preferred picture enhancement.

\*E.P.M.: Enhanced Picture Mode

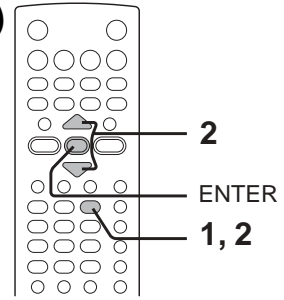

## DVD VCD CD Selecting the picture enhancement

### 1 Press E.P.M.



The picture enhancement menu appears.

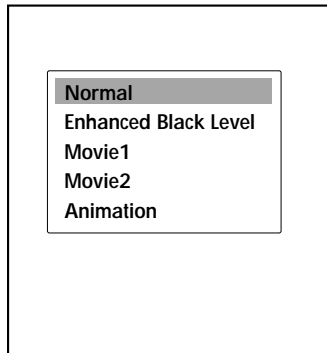

■ To exit the picture enhancement selection Press ENTER.

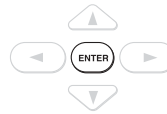

Alternatively leave the DVD video player unattended for about 5 seconds after having made a selection.

Note  
Actual effect to picture may vary depending on the TV. Make selection according to your preference.

### 2 Select the picture enhancement by pressing E.P.M. or ▲ / ▼.

Each time you press the button, the picture enhancement changes.

**Normal:**  
Standard black level (7.5 IRE).

**Enhanced Black Level:**  
Enhanced Black Level (0 IRE).

**Movie1:**  
Brightness levels raised for enhanced picture clarity.

**Movie2:**  
For deeper, richer color reproduction.

**Animation:**  
For enhanced color contrast.

# Selecting the Sound Enhancement (E.A.M.\*)

You can easily switch a preferred audio enhancement.

\*E.A.M.: Enhanced Audio Mode

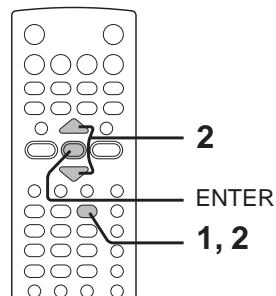

## DVD VCD Selecting the sound enhancement

### 1 Press E.A.M.



The sound enhancement menu appears.

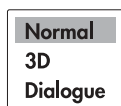

- To exit the audio enhancement selection Press ENTER.



Alternatively leave the DVD video player unattended for about 5 seconds after having made a selection.

#### Notes

- Actual effects to sounds may vary depending on the speaker system. Make selection according to your preference.
- Actual effects to sounds may vary depending on the disc.
- When the DVD video player is connected to an amplifier equipped with Dolby Surround Pro Logic, select "Normal". Otherwise, Dolby Surround Pro Logic may function differently than usual.
- Selecting "Dialogue" disables "Dynamic Range Control" function [64].

### 2 Select the sound enhancement by pressing E.A.M. or ▲/▼.

Each time you press the button, the sound enhancement changes.

**Normal:**  
Normal sound.

**3D\*:**  
To obtain expansive virtual surround sound effects from just two speakers.

**Dialogue\*\*:**  
To control dynamic range to make dialogue more intelligible.

- To use this enhancement on sounds output from the BITSTREAM/PCM jack, be sure to set "Digital Output" to "PCM." [64]

\* Effective in playback of a DVD video disc or a VIDEO CD.

\*\* Effective only during playback of Dolby Digital recorded discs.

# Selecting the Camera Angle

If the scene was recorded from multiple angles, you can easily change the camera angle of the scene you are watching.

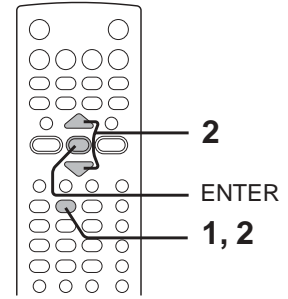
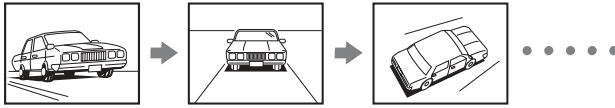

## DVD Changing the camera angle

**1** Press ANGLE while playing a scene recorded with multiple angles.



While playing a scene recorded with multiple angles, the angle icon (Ⓜ) flashes in the DVD display. Press the ANGLE button while the angle icon is flashing.

e.g.



**2** Press ANGLE or ▲ / ▼ while the angle number is displayed on the TV screen.



Each time you press the ANGLE button, the camera angle changes.



You can change the camera angle directly by pressing the number buttons corresponding to its angle number instead of using the ▲ / ▼ buttons.

To turn off the display, press the CLEAR or ENTER button.

### Notes

- You can change the camera angle during still playback. The camera angle changes to the new setting when you resume normal playback.
- If you pause a picture immediately after changing a camera angle, the resumed playback picture may not display the new camera angle.

# Selecting Subtitles

You can display subtitles on the TV screen and select a subtitle language from those included on the DVD video disc.

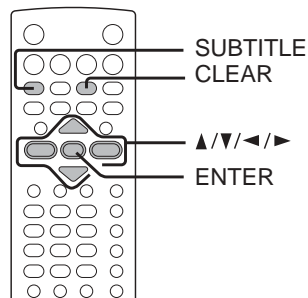

## DVD Selecting a subtitle language

### 1 Press SUBTITLE during playback.

SUBTITLE The current subtitle setting is displayed.



e.g.



The abbreviation of the language appears instead of the language name. Refer to the list of languages and their abbreviations. **70**

### 2 Press SUBTITLE or ▲ / ▼ while the subtitle setting is displayed on the TV screen.

SUBTITLE Each time you press the SUBTITLE button, the subtitle languages included on the DVD video disc change.



To turn off the subtitle setting display, press the CLEAR or ENTER button.

### ■ To turn subtitles on or off

#### 1 Press SUBTITLE during playback.

SUBTITLE



#### 2 Press ◀ / ▶ while the subtitle setting is displayed on the TV screen, to select "On" or "Off."



### Notes

- Some DVD video discs are set to display subtitles automatically, and you cannot turn them off even if you set the subtitle function to off.
- During some scenes, the subtitles may not appear immediately after you select "On."
- Some DVD video discs will allow you to make subtitle selections and turn subtitles on or off only via the disc menu.

### Notes

- When you turn on the DVD video player or replace a disc, the player returns to the initial default setting **65**. When you select a subtitle language which is not included on the disc, the DVD video player plays a prior language programmed on the disc.
- During some scenes, the subtitles may not appear immediately after you change the subtitle language.

# Selecting a Language

You can select a preferred language and sound recording system from those included on the DVD video disc.

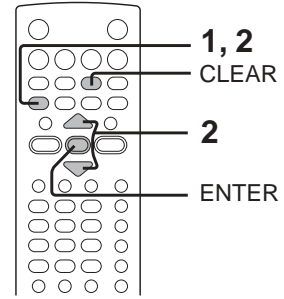
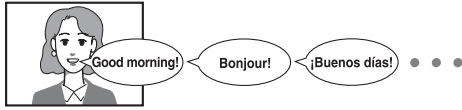

**DVD VCD** **Selecting a playback audio setting**

**1** Press AUDIO during playback.

AUDIO The current audio setting is displayed.

e.g.

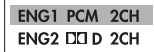

The abbreviation of the language appears instead of the language name. Refer to the list of languages and their abbreviations. **70**

**2** Press AUDIO or ▲/▼ while the audio setting is displayed on the TV screen.

AUDIO Each time you press the AUDIO button, the audio settings included on the DVD video disc change.



To turn off the audio setting display, press the CLEAR or ENTER button.

■ **Selecting sound channels of VIDEO CDs**

You can switch left and right channels by pressing the AUDIO button repeatedly during playback.



**Notes**

- When you turn on the DVD video player or replace a disc, player returns to the initial default setting **65**. If you select a sound track which is not included on the disc, the DVD video player plays a prior sound track programmed on the disc.
- Some discs allow you to change audio selections only via the disc menu. If this is the case, press the MENU button and choose the appropriate language from the selections on the disc menu.



## ■ Output sound conversion table

Input \ Output		BITSTREAM/PCM jack		ANALOG AUDIO OUT Jacks
		"Digital Output" <b>60/64</b>		
		"Bitstream"	"PCM"	
DVD video disc	Dolby Digital	Bitstream	PCM	○
	Linear PCM	PCM	PCM	○
	DTS	Bitstream	Bitstream	—
	MPEG1, MPEG2	Bitstream	PCM	○
VIDEO CD	MPEG1	PCM	PCM	○
Audio CD	Linear PCM 44.1 kHz/16 bit	PCM	PCM	○
	DTS	Bitstream	Bitstream	Noise
MP3/WMA		PCM	PCM	○

 : 3D sound enhancement can function.

- Signals of 96kHz from the BITSTREAM/PCM jack are depressed to 48 kHz by down sampling process when:
  - "3D" is selected. **39**
  - "PCM Down Sampling" is set to "On." **63**
  - a copyright protected disc is played.
- Quantization bit of signals of 20 bit or higher which is output from the BITSTREAM/PCM jack is 16 bit if they are in a copyright protected disc.

# On-screen Display Operation

When you turn on the on-screen display, you can view information on operational status and access features and settings.

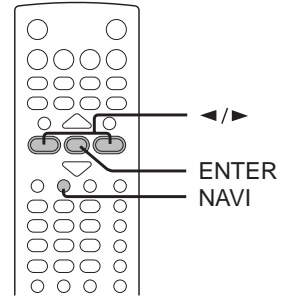

## DVD VCD CD On-screen display operation

Press NAVI.



The following display appears. Each time you press the NAVI button, the on-screen display changes as follows.

See the pages in [ ] for details on the features.

e.g. When playing a DVD video disc

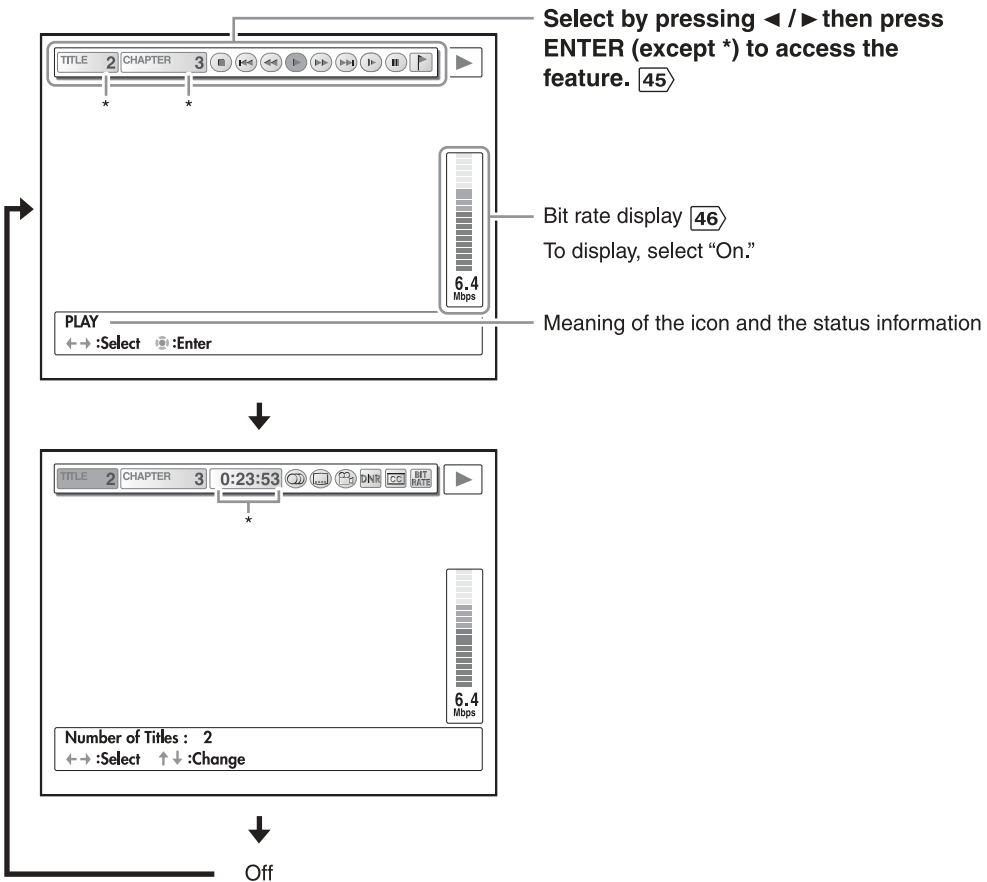

## ■ Features











(\* : There is no need to press the ENTER button.)

TITLE 2 / TRACK 2\*:

Title number (Track number)  
Locate a title or track using the number buttons. **31**

CHAPTER 3\*:

Chapter number  
Locate a chapter using the number buttons. **31**

-  : To stop playback. **27**
-  : Playback starts from the beginning of the current chapter or track. **31**
-  : Fast reverse playback **28**
-  : To start playback. **26**
-  : Fast forward playback **28**
-  : To locate succeeding chapters or tracks. **31**
-  : To begin slow motion playback. **29**
-  : To pause playback. **27**
-  : Marker  
You can set a bookmark.  
To set a bookmark:  
1 During playback, press ◀/▶ to select “”.  
2 Locate a desired point. (Pause the playback if necessary.)  
3 Press ENTER.  
The point is registered as a bookmark.

To jump to the bookmark:



- 1 During stop, press NAVI so that the on-screen display appears.
- 2 Press ◀/▶ to select “”.
- 3 Press ENTER.

### Notes

- You can save only one bookmark. Setting a new one will erase the existing one.
- There may be a difference between a marked point and the location you actually jump to.
- Some points may not be marked.
- A bookmark cannot be set when playing a PBC-featured VIDEO CD while “PBC” **68** is set to “On.”
- A bookmark will be erased when:
  - you turn off the power of the DVD video player.
  - you open the disc tray.
  - you change the parental lock setting **67** or select a disc menu language **65**.
- If a bookmark is not set, selecting “” then pressing the ENTER button during stop will start playback from the beginning of the title or the disc. (In this case, PBC control of a VIDEO CD will be disabled.)
- A bookmark on an MP3/WMA file always makes you jump to the beginning of the track.

0:23:53\*:

Elapsed time of the current title or track  
To enter the time to locate a desired location. **34**

-  : Audio setting **42**
-  : Subtitle setting **41**
-  : Angle setting **40**

(Continued)

# On-screen Display Operation (Continued)

## On-screen display operation



: DNR

You can view a picture with less video noise.

Press ▲ / ▼ to select then press ENTER.

Off: The DNR picture enhancement does not activate.

On: The DNR picture enhancement activates.

### Notes

- Actual picture enhancement may vary depending on the quality of the disc.
- While the picture enhancement can provide improvement in the reduction of noise in the video signal, it may produce undesirable picture artifacts on some discs. Should this occur, select "Off."
- Depending on the disc, some kinds of picture details may be lost by the picture enhancement.



: Closed Caption

You can display closed captions included on a disc without connecting a closed caption decoder to your TV.

Press ▲ / ▼ to select "On" or "Off" then press ENTER.

Off: To disable closed captions.

On: To display closed captions.

### Notes

- While you are using on-screen displays (including the bit rate display), you cannot view closed captions. After selecting "On" then turning off the on-screen display, closed captions will appear.
- When "On" is selected, some displays such as "▶" may be disabled.



: Bit rate (Mbit/s)

Amount of picture, sound and subtitle data in the DVD video disc transferred per second.

The larger the value is, the more data processed, but this does not necessarily insure better picture quality.

To keep the bit rate display on-screen:

Press ▲ / ▼ to select "On" then press ENTER.

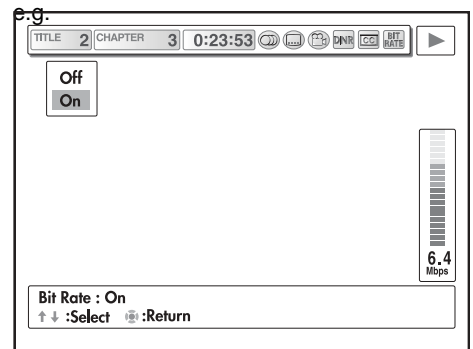

To turn it off, select "Off."

The following operations also select "Off".

- Opening the disc tray.
- Turning the power off.

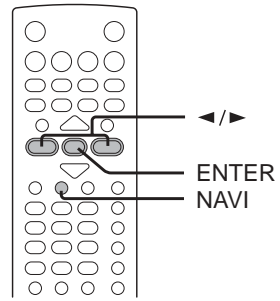

■ Viewing the operational status

1 Press DISPLAY.

The following display appears.

Time counter

Elapsed time / remaining time of the current title

Elapsed time / remaining time of the current track

e.g.

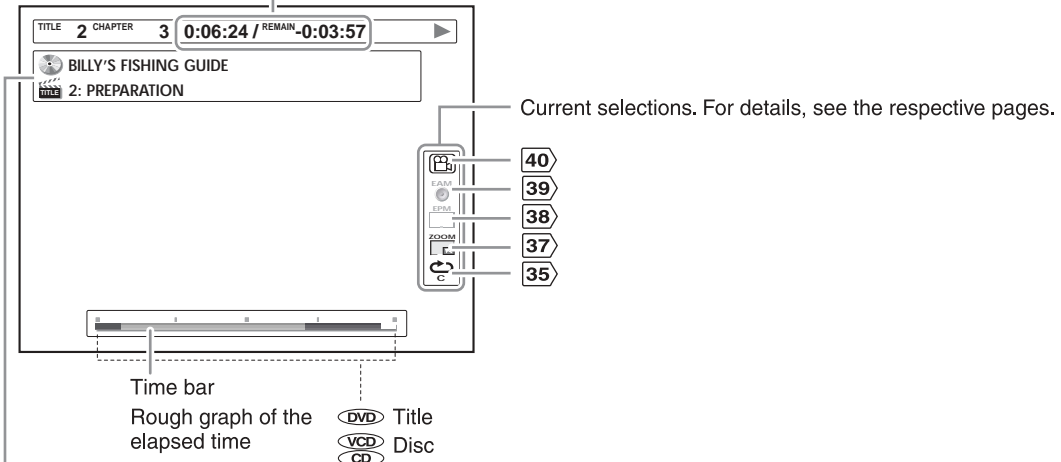

Displays DVD-Text data (or CD-Text data when playing an audio CD) if included on the disc.

(Some letters may not be displayed properly depending on the disc.)

2 To turn off the display, press DISPLAY again.

Notes

- The time bar will not appear when playing:
  - a PBC-featured VIDEO CD while "PBC" **68** is set to "On".
  - a menu included on a DVD video disc.
  - a title which does not display the elapsed time.
- Some discs may not display the time counter.
- When playing a PBC-featured VIDEO CD while "PBC" **68** is set to "On," the time counter may not work as above properly.

# Playing MP3/WMA Files

You can play MP3/WMA files that have been recorded on a CD-R or CD-ROM on the DVD video player.

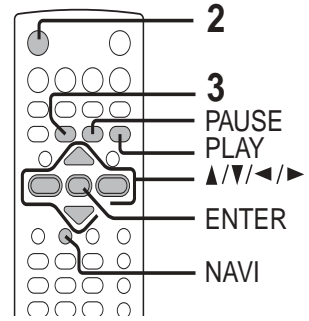

## Playing MP3/WMA files

### ■ Preparations

- Make sure that a disc you want to play is compatible with this DVD video player. **49**
- Set "Priority Contents" to "Audio". **68**

**1** Place a CD that contains MP3/WMA files on the disc tray.

---

**2** Press OPEN/CLOSE to load the disc.

OPEN/CLOSE Playback starts.



---

**3** To stop playback, press STOP.

STOP



### ■ Selecting a track (file) in the disc

- 1 Press NAVI twice.
- 2 Select the "⌂" icon using ◀/▶ then press ENTER.  
A list of tracks appears.
- 3 Press ▲/▼/◀/▶ to select a track you want to play.  
(Pressing ◀/▶ turns the pages.)  
The current track being played is highlighted in green.
- 4 Press ENTER to begin playback of the selected track.

### Notes

- You can select a track also by designating a track number. Press the T button, and press the ▲/▼ buttons to select a track number, then press the ENTER button.
- To turn off the on-screen display, press the NAVI button several times.
- Letters of a file/folder name overflowing the given space are not displayed.

### ■ To pause playback

Press PAUSE/STEP during playback.

PAUSE/STEP



To resume normal playback, press the PLAY button.

### Notes

- Some discs may not permit this operation.
- WMA tracks copy-protected cannot be played.
- The BITSTREAM/PCM jack outputs MP3/WMA sounds in the linear PCM format regardless of the current "Digital Output" selection **64**/**43**.
- If you stop playback by pressing the STOP button, and then press the PLAY button, playback will start from the beginning of the track.
- The SKIP **31** and PLAY MODE **35** functions are also available.

## ■ Playable files

MP3/WMA disc compatibility with this player is limited as follows:

- Playable discs: CD-ROM, CD-R (650MB / 74 min. only)  
CD-RW is not recommendable.
- Sampling Frequency: 44.1 kHz only
- Bit rate: WMA: 48 kbps - 192 kbps (CBR)  
MP3: 32 kbps - 320 kbps (CBR)
- CD physical format: Mode 1, Mode 2 XA Form 1
- File system: ISO9660 Level 1, 2 or Joliet
- File name: A file name should be in alphabet and numerals only, and must incorporate "MP3" or "WMA" extension.  
e.g. "\*\*\*\*\*.MP3", "\*\*\*\*\*.WMA"
- Total number of folders: Less than 256
- Total number of files: Less than 1000
- WMA codec version: V7 or V8 (Stereo sound only)

This DVD video player requires discs/recordings to meet certain technical standards in order to achieve optimal playback quality. Pre-recorded DVDs are automatically set to these standards. There are many different types of recordable disc formats (including CD-R containing MP3/WMA files). Given the fact that technology in this area is still maturing, Toshiba cannot guarantee that all genre of recordable discs will produce optimal playback quality. The technical criteria set out in this owner's manual are meant as a guide only.

Customers should also note that permission is required in order to download MP3 files and music from the internet. Toshiba has no right to grant such permission. Permission should always be sought from the copyright owner.

Microsoft, Windows Media, and the Windows Logo are trademarks or registered trademarks of Microsoft Corporation in both the United States and other countries.



# Viewing JPEG Files

You can play JPEG files that have been recorded on a CD-R or CD-ROM on the DVD video player. You can select a preferred view: a page of 6 thumbnail images, a single image view, and slide show of a selected folder.

Also, rotating, enlarging and shifting of each image can be possible.

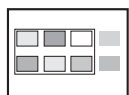

Thumbnail view

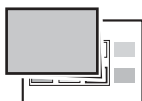

Single image view



Slide show

## Starting from a thumbnail view

### ■ Preparations

- Prepare a disc that contains JPEG files you want to view. **57**
- Set "Priority Contents" to "Photo". **68**
- Make your TV shape conform to the 4:3 picture size. Only 4:3 pictures can be played regardless of the function settings via the on-screen displays of the DVD video player. If the TV is adjusted to other sizes, e.g. "WIDE," images will appear to be horizontally expanded. For details, refer to the owner's manual of your TV.

**1** Press OPEN/CLOSE to open the disc tray.

OPEN/CLOSE



**2** Place a disc that contains JPEG files on the disc tray.

**3** Press OPEN/CLOSE.

OPEN/CLOSE



The disc tray closes, and the DVD video player reads the loaded disc.

After completion of reading, the DVD video player enters either of the following modes, and provides the respective displays, depending on the condition of the disc contents. Proceed to steps described below.

A thumbnail view appears.  
(Automatic mode)  
e.g.

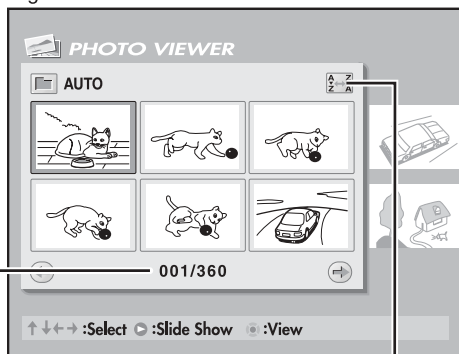

Icon of reverse order **52**

Number of a current selection / Number of images to play

Proceed to step 4 on **51**.

A list of folders in the disc appears.  
(Selection mode)  
e.g.

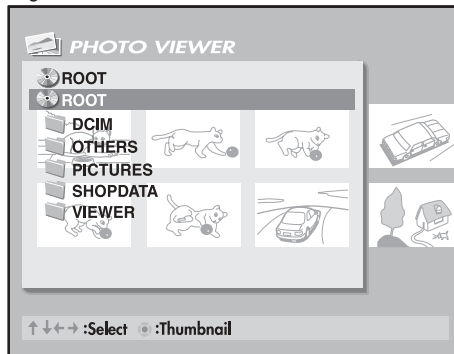

Refer to **56**, "Selecting a folder."



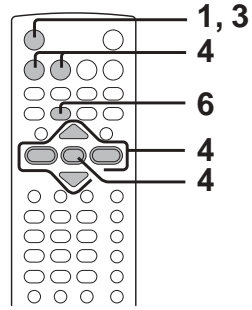

**4** Turn the page if necessary.  
 Press ▲/▼/◀/▶ to select the last image of 6, then press ►.  
 (Press ▲/▼/◀/▶ to select the first image of 6, then press ◀.)

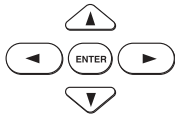

Selecting ◀ (or ▶) then pressing the ENTER button also turns the pages.

Alternatively,  
 Press SKIP.



▶▶: To view the succeeding 6 images.  
 ◀◀: To view the previous 6 images.

The page changes as follows:

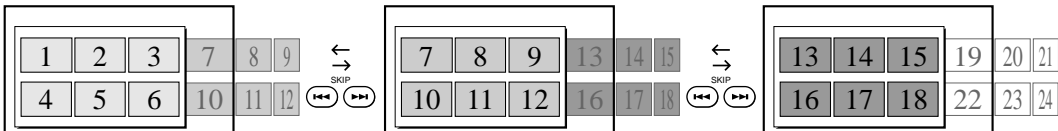

**5** Select the viewing options at your preference.  
 - Viewing a single image: See **53**.  
 - Playing slide show: See **55**.

**6** To quit the JPEG playback, press STOP.



- If you press the PLAY button after pressing the STOP button, you can return to the thumbnail view.
- Pressing the OPEN/CLOSE button to open the disc tray can also quit the playback.

- Notes
- If you display a thumbnail view from the automatic mode and leave it unattended for approximately 20 seconds, slide show starts automatically.
  - When "Screen Saver" is set to "On" **66**, a thumbnail view which is unattended for about 10 minutes automatically changes to slide show.
  - Some files may not display their own entire images depending on the size.

# Viewing JPEG Files (Continued)

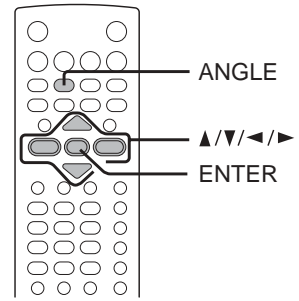

## Starting from a thumbnail view

■ To reverse the order

Some cameras may have given the first file number (e.g. 01) always to the latest photo. When you play such files, reverse the order of images. You can view them in order of time.

Press ▲/▼/◀/▶ to select “” then press ENTER.

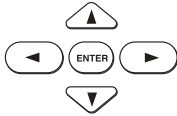

**Note**  
The order of images will be restored when you open the disc tray or turn the power off.

■ To display a folder list

1 Press ▲/▼/◀/▶ to select “”.

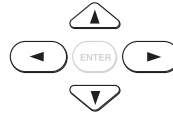

2 Press ENTER.

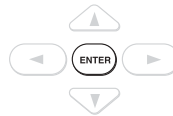

A folder list appears.

You can select a folder to play. For details, see page **56**.

■ To set an image rotation on a thumbnail view

1 Select an image by pressing ▲/▼/◀/▶.

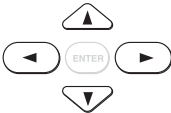

2 Press ANGLE repeatedly.



Each time you press the ANGLE button, you can set a rotation of the image in 90° increment.

**Note**  
Quitting the JPEG playback restores a rotated image to its original posture.

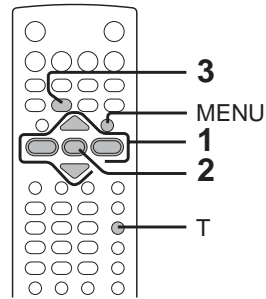

## Viewing a single image

**1** On a thumbnail view, select an image by pressing ▲/▼/◀/▶.

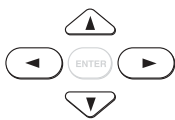

**2** Press ENTER.

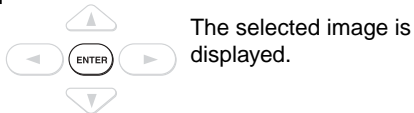

**3** To quit the JPEG playback, press STOP.



- If you press the PLAY button after pressing the STOP button, slide show **55** starts.
- Pressing the OPEN/CLOSE button to open the disc tray can also quit the playback.

### Notes

- Some files may not display their own entire image depending on the size.
- When "Screen Saver" is set to "On" **66**, a single image which is unattended for about 10 minutes automatically changes to slide show.

■ To confirm a photo number

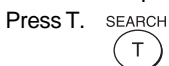

### Notes

- To turn it off, press the T button.
- You can locate an image by entering its number. While displaying a photo number, press the number buttons to enter a number then press the ENTER button. Slide show will start from the located image.

■ To change the image

To view the succeeding image, press ▶ or ENTER.



To view the previous image, press ◀.



### Notes

- Change of images will be reversed if you reverse the order of images.
- You can view the succeeding image also by pressing the PAUSE/STEP or SKIP ►► button.

■ To reverse the order

1 Press MENU.



The following menu appears for about 5 seconds.  
e.g.

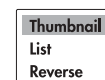

2 Press ▲/▼ to select "Reverse" then press ENTER.



### Note

Whenever you change the order, the first or last of images to be played will be located.

# Viewing JPEG Files (Continued)

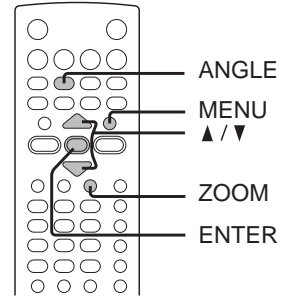

## Viewing a single image

- To magnify an image  
Press ZOOM repeatedly.



Each time you press the ZOOM button, the magnification level changes as follows:

"Zoom Off" (The icon and monitor scope appear.) →  
 "Zoom1" → "Zoom2" → "Zoom3" (Maximum) →  
 "Shrink" → Original size (The icon and monitor scope disappear.)

**Notes**

- To turn off the icon and monitor scope, press the ▲/▼/◀/▶ buttons to select "EXIT" in the icon, then press the ENTER button.
- While changing the magnification level, you can shift the image. Press and hold the ▲/▼/◀/▶ buttons.
- Exiting an image cancels the current selection of the magnification level.

- To rotate an image  
Press ANGLE repeatedly.



The image rotates by clockwise 90-degree.

**Notes**

- If you rotate an image of which magnification level is changed, the size of the image is restored momentarily.
- Quitting the JPEG playback restores a rotated image to its original posture.
- The DVD video player may redo displaying an image if you rotate it.

- To display a folder list

- 1 Press MENU.



The following menu appears for about 5 seconds.  
e.g.

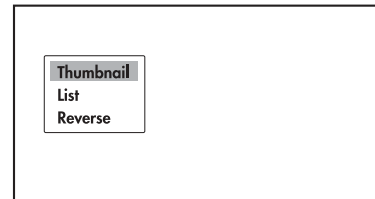

- 2 Press ▲/▼ to select "List" then press ENTER.

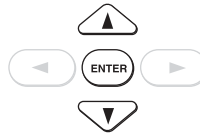

A folder list appears.

You can select a folder to play. For details, see page [56](#).

- To return to the thumbnail view

- 1 Press MENU.



- 2 Press ▲/▼ to select "Thumbnail" then press ENTER.



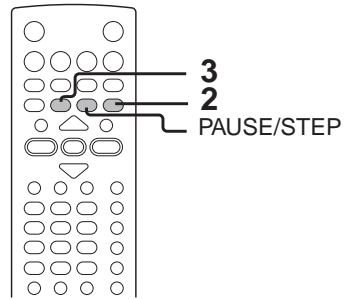

## Playing slide show

- 1** On a thumbnail view, select an image from which you want to start slide show.  
You can skip this step. Slide show will start from a photograph currently selected.

- 2** Press PLAY.  
Slide show starts.
- 

- 3** To quit the JPEG playback, press STOP.
- 
- If you press the PLAY button after pressing the STOP button, the slide show resumes.
  - Pressing the OPEN/CLOSE button to open the disc tray can also quit the playback.

- To confirm a photo number  
See [53](#).
- To magnify an image  
See [54](#).

Note  
Slide show pauses if you press the ZOOM button.

- To rotate an image  
See [54](#).
- To display a folder list  
See [54](#).
- To return to the thumbnail view  
See [54](#).

- To view a single image (To pause slide show)  
Press PAUSE/STEP.



# Viewing JPEG Files (Continued)

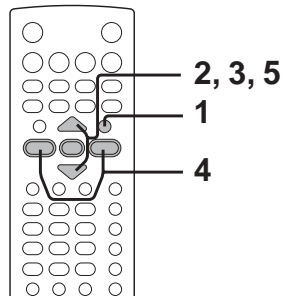

## Selecting a folder

You can designate a folder to play.

**1** On a single image view or during slide show, press MENU.



The following menu appears for about 5 seconds.  
e.g.

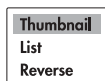

To display a folder list also from a thumbnail view, follow the procedure on [52](#), and skip to step 3.

**2** Press ▲/▼ to select "List" then press ENTER.

A folder list appears.

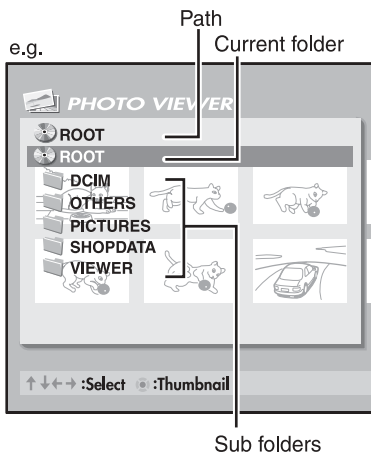

**4** Press ◀/▶ to select a folder.



- ▶ : If you press this button while selecting a sub folder, you can view the contents of the folder.
  - Sub folders will appear if contained in the selected folder.
  - If the selected folder contains a file to view, a thumbnail image of the file will appear in the background.
- ◀ : If you press this button while selecting a current folder, you can go back to the previous folder.

**5** After thumbnails appear in the background, press ENTER.



The thumbnail view of the current folder appears.  
For operations of thumbnail view, see [51](#).

**3** Press ▲/▼ to select a folder.

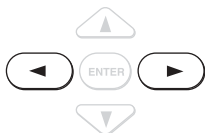

### Notes

- The first thumbnail view provided by the automatic mode may not return once you display a folder list. You can retrieve it if you load the disc again.
- Letters of a folder/path name overflowing the given space are not displayed.

## JPEG files compatibility

Discs whose compatibility with this DVD video player has been confirmed by TOSHIBA are as follows. Many of these discs, when loaded, will make the DVD video player enter the automatic mode **50** to play a prescribed folder in the disc. To play other folders, display a folder list and select a folder.

CANON QuickCD  
FUJICOLOR CD  
Kodak Picture CD  
NORITSU QSS CD

JPEG disc compatibility with this DVD video player is limited as follows:

- Playable discs: CD-ROM, CD-R (650MB / 74 min. only)  
CD-RW is not recommendable.
- CD physical format: Mode 1, Mode 2 XA Form 1
- File system: ISO9660 Level 1, 2 or Joliet
- File name: A file name should be in alphabet and numerals only, and must incorporate extension.  
"JPG" e.g. "\*\*\*\*\*.JPG"
- Total number of folders: Less than 256
- Total number of files: Less than 1000

Some files may not display their own entire image depending on the size.

Some discs may not permit this operation. Especially, the following conditions of included files will increase the disc's disability.

1. Pixels over 3072 × 2048 in height and/or width
2. File format except Exif





# Function setup

You can change the default settings to customize performance to your preference.

- Customizing the Function Settings
- Table of Languages

# Customizing the Function Settings

You can change the default settings to customize performance to your preference.

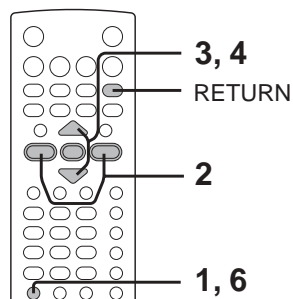

**DVD**  
**VCD**  
**CD**

## Setting procedure

**1** Press SETUP during stop.



The following on-screen display appears.

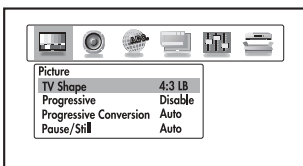

**2** Press ◀/▶ to select a symbol for the setting you want to change.

(See the next page.)

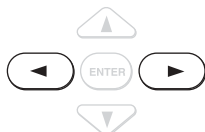

Picture performance settings



Output sound settings



Language settings



Display settings



Operational settings



Initial setup

**3** Press ▲/▼ to select the setting you want to change, then press ENTER.

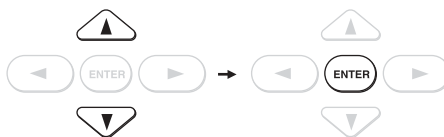

**4** Change the selection by ▲/▼ or other buttons, by referring to the corresponding pages (62 -), then press ENTER.

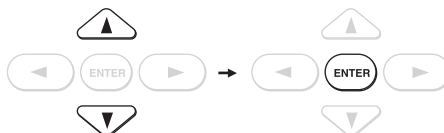

**5** Repeat steps 3 and 4 to change other settings. To select another operation, go back to step 2.

**6** Press SETUP.

The on-screen display disappears.







































■ To return to the previous display Press RETURN.



**Notes**

- To quit the procedure, press the SETUP button to turn off the on-screen display.
- The SETUP button can function even during normal playback, however some operations may be inaccessible, and a message will appear. In this case, try again after playback is stopped.

Setting		Details	Page	
	TV Shape	 	To select a picture size according to the aspect ratio of your TV.	62
	Progressive	 	To select whether you send progressive signals to the connected TV or not.	62
	Progressive Conversion		To select the system of output signal. (Only when connected to a PROGRESSIVE TV.)	62
	Pause/Still		To select the resolution of still pictures.	63
	PCM Down Sampling		To select a sound processing option for PCM sounds if they are high frequency signals of 96 kHz.	63
	Digital Output	  	To select an output sound format corresponding to your system connection.	64
	Dynamic Range Control		To turn on or off a function that makes faint sounds easier to hear even if you lower the volume during late hours playback.	64
	Karaoke Vocal		To turn on or off the vocal output during DVD KARAOKE disc playback.	64
	On-Screen Language	  	To select a preferred language for on-screen displays.	65
	Disc Menu Language		To select a preferred language for disc menus.	65
	Audio Language		To select a preferred language for the sound track.	65
	Subtitle Language		To select a preferred language for subtitles.	65
	On-Screen Displays	  	To turn on or de-activate the operational status display on the TV screen.	66
	Background	  	To select the background color or background picture.	66
	Screen Saver		To turn the screen saver on or off.	66
				66
	Parental Lock		To turn the parental lock function on or off.	67
	Title Stop		To turn on or off a feature that automatically stops playback after a title has been viewed.	68
	PBC		To use the menu screen when playing a PBC-controllable VIDEO CD.	68
	Priority Contents		To select the playback priority between JPEG (picture) files and MP3/WMA (audio) files.	68
	On-Screen Language TV Shape	  	To install the initial system setting.	69

## Customizing the Function Settings (continued)

### Setting details

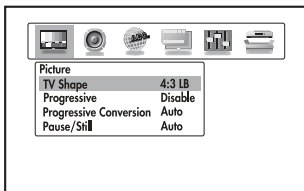

#### TV Shape DVD VCD

**4:3 Letterbox:** Select when a standard 4:3 TV is connected. Displays theatrical images with masking bars above and below the picture.



**4:3 Normal:** Select when a standard 4:3 TV is connected. Displays pictures cropped to fill your TV screen. Either or both sides of the picture are cut off.



**16:9 Widescreen:** Select when a 16:9 wide TV is connected.

**16:9 Shrink:** Select when a 16:9 wide progressive TV is connected and it cannot fit 4:3 video signal automatically to its 16:9 screen. Displays 4:3 pictures of the progressive video signal in the correct ratio with masking bars to the left and right of the picture.

#### Notes

- The displayable picture size is preset on the DVD video disc. Therefore, the playback picture of some DVD video discs may not conform to the picture size you select.
- If you select "16:9 Widescreen" and you own a 4:3 TV set, the DVD playback picture will be horizontally distorted during playback. Images will appear to be horizontally compressed. Always be sure that your TV shape conforms to the actual TV in use.

#### Progressive DVD VCD

**Disable:** Select when a standard (non-progressive) TV is connected. **18** **19**

**Enable:** Select when a progressive TV is connected. **19**  
Press PROGRESSIVE on the remote control to switch the output signal for better picture quality.

#### Note

When "Enable" is set and you select the progressive output signal, no video signals are output from the VIDEO OUT jack and the S VIDEO OUT jack.

#### Progressive Conversion DVD

There are two types of source content in pictures recorded in DVD video discs: film content (pictures recorded from films at 24 frames per second) and video content (video signals recorded at 30 frames per second). Make this selection according to the type of content being viewed.

- Auto:** Select this position normally. The DVD video player automatically detects source content, film or video, of playback source, and converts that signal to the progressive output format in an appropriate method.
- Video:** The DVD video player filters video signal, and converts it to the progressive output format appropriately. Suitable for playback of video content pictures.
- Film:** The DVD video player converts film content pictures to the progressive output format appropriately. Suitable for playback of film content pictures. The progressive output feature will be most effective under this selection.

#### Note

Depending on the disc, pictures may be cut off or doubled. In this case, select "Video."

## Pause/Still DVD

**Auto:** For normal use. Still and fast motion images can be paused.

**Frame:** The resolution of still pictures is improved, so that you can make a motionless picture more clearer when you pause it.

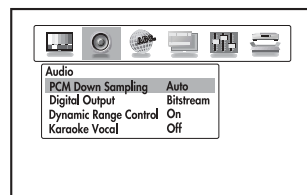

## PCM Down Sampling DVD

According to performance of your connected audio system, select a sound processing option for playback of a disc that contains high frequency signals (sampling frequency 96 kHz).

- Off:** Select when you make a connection via the ANALOG AUDIO OUT jacks. The DVD video player outputs PCM signals with no conversion. However, if the PCM signals are copy-protected, they are not output from the BITSTREAM/PCM DIGITAL AUDIO jack, unless they are 48 kHz/16 bit signals.
- Auto:** Select when your connected audio system processes high frequency signals of 96 kHz. The DVD video player outputs PCM signals with no conversion. However, if the PCM signals are copy-protected, they are down-sampled to 48 kHz/16 bit.
- On:** Select when your connected audio system does not process high frequency signals of 96 kHz. The DVD video player down-samples PCM signals to 48 kHz.

### Note

If you select "Off" or "Auto" because your connected audio system does not process high frequency signals of 96 kHz, you will not hear output sound from those signals.

## Customizing the Function Settings (continued)

### Setting details

#### Digital Output DVD VCD CD

Select the output sound format corresponding to your system connection.  
For details of sound recording systems, see 43.

**Bitstream:** Select when connected to an amplifier equipped with a Dolby Digital, DTS, MPEG1 or MPEG2 decoder. 21 22  
The DVD video player outputs digital audio information in the bitstream format when you play a DVD video disc recorded on the Dolby Digital, DTS, MPEG1 or MPEG2 recording system.

**PCM:** Select when connected to a 2 channel digital stereo amplifier. 23  
The DVD video player outputs sounds in the PCM 2ch format when you play a DVD video disc recorded on the Dolby Digital, MPEG1 or MPEG2 recording system.

**Note**

When you make a connection to a TV, or Dolby Surround Pro Logic or stereo system via the analog audio jacks, select "Bitstream" or "PCM."

#### Dynamic Range Control DVD

**Off:** Full dynamic range is maintained.  
**On:** Dynamic range is reduced.

**Note**

The level of Dynamic Range Reduction may differ depending on the DVD disc.

#### Karaoke Vocal DVD

**Off:** The primary vocal is not output.  
**On:** The primary vocal is output when it is recorded on the disc.

**Notes**

- The vocal output feature is used during playback of Dolby Digital (multi-channel) recorded DVD KARAOKE discs. This feature allows you to turn off vocal audio tracks, or restore them for background accompaniment.
- When playing KARAOKE, connect appropriate audio equipment such as an amplifier to the DVD video player.

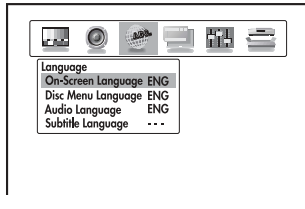

### On-Screen Language DVD VCD CD

English: To view on-screen displays in English.  
 Français: To view on-screen displays in French.  
 Español: To view on-screen displays in Spanish.

### Disc Menu Language DVD

English: To display disc menus in English.  
 French: To display disc menus in French.  
 Spanish: To display disc menus in Spanish.  
 Others: To make a further choice.  
 After pressing the ENTER button, follow steps 1) - 4) below.

- 1) Obtain the abbreviation of the preferred language from the list 70.
- 2) Select the first character by pressing the ▲ / ▼ buttons.
- 3) Press the ◀ / ▶ buttons to shift and select the second character by pressing the ▲ / ▼ buttons.

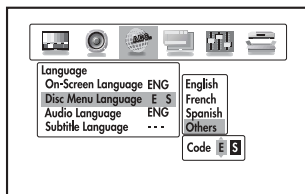

- 4) Press the ENTER button.

**Note**  
 Some DVD video discs may not include your pre-selected language. In this case, the DVD video player automatically displays disc menus consistent with the disc's initial language setting.

### Audio Language DVD

English: To play sound tracks in English.  
 French: To play sound tracks in French.  
 Spanish: To play sound tracks in Spanish.  
 Others: To make a further choice.  
 After pressing the ENTER button, follow steps 1) - 4) below.

- 1) Obtain the abbreviation of the preferred language from the list 70.
- 2) Select the first character by pressing the ▲ / ▼ buttons.
- 3) Press the ◀ / ▶ buttons to shift and select the second character by pressing the ▲ / ▼ buttons.

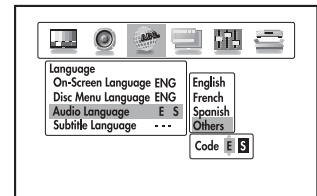

- 4) Press the ENTER button.

**Note**  
 Some DVD video discs may be played in a different language than you selected. A prior language may be programmed on the disc.

### Subtitle Language DVD

English: To display subtitles in English.  
 French: To display subtitles in French.  
 Spanish: To display subtitles in Spanish.  
 No Subtitle: To disable subtitles.  
 Others: To make a further choice.  
 After pressing the ENTER button, follow steps 1) - 4) below.

- 1) Obtain the abbreviation of the preferred language from the list 70.
- 2) Select the first character by pressing the ▲ / ▼ buttons.

(Continued)

# Customizing the Function Settings (continued)

## Setting details

(Continued)

- 3) Press the ◀/▶ buttons to shift and select the second character by pressing the ▲/▼ buttons.

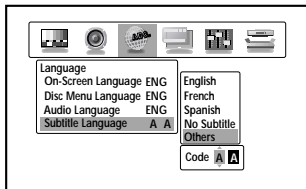

- 4) Press the ENTER button.

**Notes**

- Some DVD video discs may be set to display subtitles in a different language than you selected. A prior subtitle language may be programmed on the disc.
- Some DVD video discs allow you to change subtitle selections only via the disc menu. If this is the case, press the MENU button and choose the appropriate subtitle language from the selection on the disc menu.

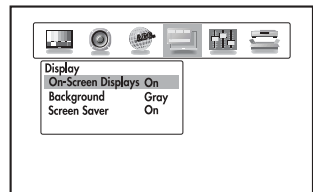

### On-Screen Displays (DVD) (VCD) (CD)

- Off: Operational modes (e.g. "□□", "▶▶") are not displayed.
- On: Operational modes (e.g. "□□", "▶▶") are displayed on-screen.

### Background (DVD) (VCD) (CD)

- Blue: Blue background.
- Gray: Gray background.
- Picture: To use the picture which appears when you turn on the DVD video player as a background.
- Jacket: To use the jacket picture included on some DVD video discs as a background. If it is not included, a gray background will be substituted.

### Screen Saver (DVD)

- Off: The screen saver is disengaged.
- On: The screen saver operates.

### FL Dimmer (DVD) (VCD) (CD)

- Off: Normal brightness.
- Half: The DVD display is dimmed.
- Full: The DVD display does not illuminate.



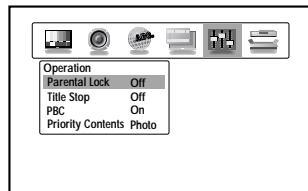
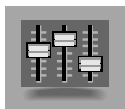

## Parental Lock DVD

DVD video discs equipped with the parental lock function are rated according to their content. The contents allowed by a parental lock level and the way a DVD video disc can be controlled may vary from disc to disc. For example, if the disc allowed you could edit out violent scenes unsuitable for children and replace them with more suitable scenes, or lock out playback of the disc altogether.

- DVD video discs may or may not respond to the parental lock settings. This is not a defect in the DVD video player. Make sure this function works with your DVD video discs.

- Off:** The parental lock feature does not function. After pressing the ENTER button, follow step 1) below.
- On:** To activate the parental lock feature or change the settings. After pressing the ENTER button, follow steps 1) - 3) below.

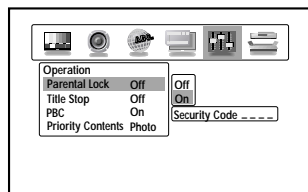

- 1) Press the number buttons to create a personal 4-digit security code, then press the ENTER button.  
If you make a mistake before pressing the ENTER button, press the CLEAR button and enter your 4-digit security code again.
- 2) Enter the code of a country/area whose standards were used to rate the DVD video disc, referring to the list below.

Country/Area	Code
AUSTRALIA	AU
BELGIUM	BE
CANADA	CA
CHINA	CN
CHINA HONG KONG	HK
DENMARK	DK
FINLAND	FI
FRANCE	FR
GERMANY	DE
INDONESIA	ID
ITALY	IT
JAPAN	JP
MALAYSIA	MY
NETHERLANDS	NL
NORWAY	NO
PHILIPPINES	PH
RUSSIAN FEDERATION	RU
SINGAPORE	SG
SPAIN	ES
SWEDEN	SE
SWITZERLAND	CH
TAIWAN	TW
THAILAND	TH
UNITED KINGDOM	GB
UNITED STATES	US

- a) Select the first character by pressing the ▲ / ▼ buttons.
- b) Press the ◀ / ▶ buttons to shift and select the second character by pressing the ▲ / ▼ buttons.
- c) Press the ENTER button.

(Continued)

# Customizing the Function Settings (continued)

## Setting details

(Continued)

- Press the ▲ / ▼ buttons to select the parental lock level, then press the ENTER button.

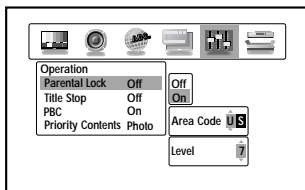

You cannot play DVD video discs rated higher than the level you selected unless you cancel the parental lock function.

For example, when you select level 7, discs rated higher than level 7 are locked out and cannot be played.

The parental lock level is equivalent to the following USA movie ratings.

- Level 7: NC-17
- Level 6: R
- Level 4: PG 13
- Level 3: PG
- Level 1: G

The parental lock levels for other countries/areas than U.S. are included for future use. Check the appropriate parental lock level when you buy a DVD video disc equipped with the parental lock feature in the future.

- To change the parental lock level  
Follow steps 1) - 3).
- To change your 4-digit security code
  - After selecting "On" or "Off," press the STOP button four times, then press the ENTER button.

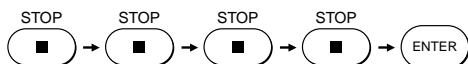

The 4-digit security code is cleared.

- Press the number buttons to create a new 4-digit security code.
- Press the ENTER button.

### Title Stop DVD

- Off: The DVD video player continues after playback of a title is completed.
- On: The DVD video player stops after playback of a title is completed.

### PBC VCD

- Off: When playing a VIDEO CD without using the menu.
- On: To use the menu when playing a PBC-featured VIDEO CD.

### Priority Contents

To select the playback priority between JPEG (picture) files and MP3/WMA (audio) files.

- Photo: JPEG files take priority over MP3/WMA files.
- Audio: MP3/WMA files take priority over JPEG files.

**Note**  
If this selection does not correspond to disc contents, the DVD video player will take a longer time to start playback of the disc.

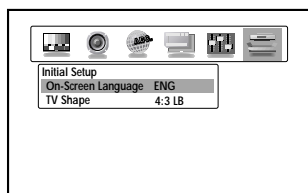

### Initial Setup DVD VCD CD

- 1) Press the ▲ / ▼ buttons to select "On-Screen Language," and press the ENTER button.

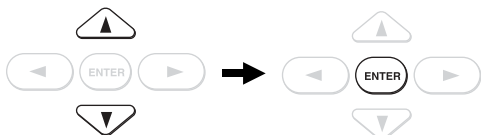

- 2) Select a language pressing the ▲ / ▼ buttons, and press the ENTER button.

See page [65](#), "On-screen Language."

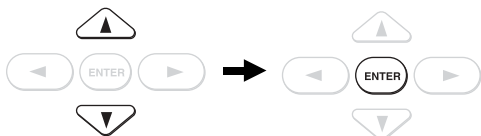

- 3) Make your selection in the same manner as step 1) then step 2).

See page [62](#), "TV Shape."

# Table of Languages

## Table of languages and their abbreviations

Abbreviation	Language	Abbreviation	Language	Abbreviation	Language
---	No alternate language	GN	Guarani	PT	Portuguese
CHI (ZH)	Chinese	GU	Gujarati	QU	Quechua
DUT (NL)	Dutch	HA	Hausa	RM	Rhaeto-Romance
ENG (EN)	English	HI	Hindi	RN	Kirundi
FRE (FR)	French	HR	Croatian	RO	Rumanian
GER (DE)	German	HU	Hungarian	RU	Russian
ITA (IT)	Italian	HY	Armenian	RW	Kinyarwanda
JPN (JA)	Japanese	IA	Interlingua	SA	Sanskrit
KOR (KO)	Korean	IE	Interlingue	SD	Sindhi
MAY (MS)	Malay	IK	Inupiak	SG	Sango
SPA (ES)	Spanish	IN	Indonesian	SH	Serbo-Croatian
AA	Afar	IS	Icelandic	SI	Singhalese
AB	Abkhazian	IW	Hebrew	SK	Slovak
AF	Afrikaans	JI	Yiddish	SL	Slovenian
AM	Amharic	JW	Javanese	SM	Samoaan
AR	Arabic	KA	Georgian	SN	Shona
AS	Assamese	KK	Kazakh	SO	Somali
AY	Aymara	KL	Greenlandic	SQ	Albanian
AZ	Azerbaijani	KM	Cambodian	SR	Serbian
BA	Bashkir	KN	Kannada	SS	Siswati
BE	Belorussian	KS	Kashmiri	ST	Sesotho
BG	Bulgarian	KU	Kurdish	SU	Sundanese
BH	Bihari	KY	Kirghiz	SV	Swedish
BI	Bislama	LA	Latin	SW	Swahili
BN	Bengali, Bangla	LN	Lingala	TA	Tamil
BO	Tibetan	LO	Laotian	TE	Telugu
BR	Breton	LT	Lithuanian	TG	Tajik
CA	Catalan	LV	Latvian, Lettish	TH	Thai
CO	Corsican	MG	Malagasy	TI	Tigrinya
CS	Czech	MI	Maori	TK	Turkmen
CY	Welsh	MK	Macedonian	TL	Tagalog
DA	Danish	ML	Malayalam	TN	Setswana
DZ	Bhutani	MN	Mongolian	TO	Tongan
EL	Greek	MO	Moldavian	TR	Turkish
EO	Esperanto	MR	Marathi	TS	Tsonga
ET	Estonian	MT	Maltese	TT	Tatar
EU	Basque	MY	Burmese	TW	Twi
FA	Persian	NA	Nauru	UK	Ukrainian
FI	Finnish	NE	Nepali	UR	Urdu
FJ	Fiji	NO	Norwegian	UZ	Uzbek
FO	Faroese	OC	Occitan	VI	Vietnamese
FY	Frisian	OM	(Afan) Oromo	VO	Volapük
GA	Irish	OR	Oriya	WO	Wolof
GD	Scottish Gaelic	PA	Panjabi	XH	Xhosa
GL	Galician	PL	Polish	YO	Yoruba
		PS	Pashto, Pushto	ZU	Zulu

# Others

- Before Calling Service Personnel
- Specifications
- LIMITED WARRANTY DVD VIDEO PLAYER

## Before Calling Service Personnel

Check the following guide for the possible cause of a problem before contacting service.

### Symptoms and correction

Symptom	Cause	Correction	Page
No power.	<ul style="list-style-type: none"> <li>The power plug is disconnected.</li> </ul>	<ul style="list-style-type: none"> <li>Connect the power plug securely into the wall outlet.</li> </ul>	18
The DVD video player turned off by itself.	<ul style="list-style-type: none"> <li>The automatic power off function turned the unit off.</li> </ul>	<ul style="list-style-type: none"> <li>Press the PLAY button.</li> </ul>	27
No picture.	<ul style="list-style-type: none"> <li>The TV is not set to receive DVD signal output.</li> </ul>	<ul style="list-style-type: none"> <li>Select the appropriate video input mode on the TV so the picture from the DVD video player appears on the TV screen.</li> </ul>	26
	<ul style="list-style-type: none"> <li>The video cable is not connected securely.</li> </ul>	<ul style="list-style-type: none"> <li>Connect the video cable securely into the appropriate jacks.</li> </ul>	18, 19
No sound.	<ul style="list-style-type: none"> <li>The equipment connected with the audio cable is not set to receive DVD signal output.</li> </ul>	<ul style="list-style-type: none"> <li>Select the correct input mode of the audio receiver so you can listen to the sound from the DVD video player.</li> </ul>	26
	<ul style="list-style-type: none"> <li>The audio cable is not connected securely.</li> </ul>	<ul style="list-style-type: none"> <li>Connect the audio cable securely into the appropriate jacks.</li> </ul>	18 – 23
	<ul style="list-style-type: none"> <li>The audio receiver or TV is turned off.</li> </ul>	<ul style="list-style-type: none"> <li>Turn on the equipment connected with the audio cable.</li> </ul>	26
	<ul style="list-style-type: none"> <li>The setting of output sound format is incorrect.</li> </ul>	<ul style="list-style-type: none"> <li>Select the proper audio setting.</li> </ul>	43, 60 64
The playback picture has occasional distortion.	<ul style="list-style-type: none"> <li>The disc is dirty.</li> </ul>	<ul style="list-style-type: none"> <li>Eject the disc and clean it.</li> </ul>	9
	<ul style="list-style-type: none"> <li>It is in fast forward or fast reverse playback.</li> </ul>	<ul style="list-style-type: none"> <li>Sometimes a small amount of picture distortion may appear. This is not a malfunction.</li> </ul>	–
Brightness is unstable or noises are present in the playback pictures.	<ul style="list-style-type: none"> <li>The effect of copy protection.</li> </ul>	<ul style="list-style-type: none"> <li>Connect the DVD video player directly to the TV. Avoid connecting the DVD video player to a VCR or TV/VCR combination.</li> </ul>	18
The DVD video player does not start playback.	<ul style="list-style-type: none"> <li>No disc is inserted.</li> </ul>	<ul style="list-style-type: none"> <li>Insert a disc.</li> </ul>	26
	<ul style="list-style-type: none"> <li>An unplayable disc is inserted.</li> </ul>	<ul style="list-style-type: none"> <li>Insert a playable disc. (Check the disc type and color system.)</li> </ul>	10
	<ul style="list-style-type: none"> <li>The disc is placed upside down.</li> </ul>	<ul style="list-style-type: none"> <li>Place the disc with the playback side down.</li> </ul>	26
	<ul style="list-style-type: none"> <li>The disc is not placed within the guide.</li> </ul>	<ul style="list-style-type: none"> <li>Place the disc correctly inside the guide on the disc tray.</li> </ul>	26
	<ul style="list-style-type: none"> <li>The disc is dirty.</li> </ul>	<ul style="list-style-type: none"> <li>Clean the disc.</li> </ul>	9
	<ul style="list-style-type: none"> <li>The parental lock function is set.</li> </ul>	<ul style="list-style-type: none"> <li>Cancel the parental lock function or change the parental lock level.</li> </ul>	60, 67
Playback does not follow the course of the disc's program.	<ul style="list-style-type: none"> <li>It is in the mode of repeat playback, memory playback, etc.</li> </ul>	<ul style="list-style-type: none"> <li>These operations may prevent a proper progress of the contents.</li> </ul>	–
Buttons do not work.	<ul style="list-style-type: none"> <li>Power supply fluctuations or other abnormalities such as static electricity may interrupt correct operations.</li> </ul>	<ul style="list-style-type: none"> <li>Press and hold the ON/STANDBY button on the front panel for more than about 3 seconds. The DVD video player turns off. Press the button again to turn it on. If the buttons still do not work, disconnect the power plug and insert it into the wall outlet again.</li> </ul>	–
The remote control does not work properly.	<ul style="list-style-type: none"> <li>The remote control is not pointed at the remote sensor of the DVD video player.</li> </ul>	<ul style="list-style-type: none"> <li>Point the remote control at the remote sensor of the DVD video player.</li> </ul>	15
	<ul style="list-style-type: none"> <li>The remote control is too far from the DVD video player.</li> </ul>	<ul style="list-style-type: none"> <li>Operate the remote control within about 7 m.</li> </ul>	15
	<ul style="list-style-type: none"> <li>The batteries in the remote control are exhausted.</li> </ul>	<ul style="list-style-type: none"> <li>Replace the batteries with new ones.</li> </ul>	15

## DVD video player / outputs / supplied accessories

### DVD Video Player

Power supply	120 V AC, 60 Hz
Power consumption	14 W
Mass	2.2 kg
External dimensions	430 x 50 x 200 mm (W/H/D)
Signal system	Standard NTSC
Laser	Semiconductor laser, wavelength 650/780 nm
Frequency range	DVD linear sound : 48 kHz sampling 4 Hz to 22 kHz 96 kHz sampling 4 Hz to 44 kHz
Signal-to-noise ratio	More than 112 dB
Audio dynamic range	More than 102 dB
Harmonic distortion	Less than 0.002 %
Wow and flutter	Below measurable level (less than $\pm 0.001$ % (W.PEAK))
Operating conditions	Temperature: 5 °C to 35 °C, Operation status: Horizontal

### Outputs

Video output	1.0 V (p-p), 75 $\Omega$ , negative sync., pin jack $\infty$ 1
S video output	(Y) 1.0 V (p-p), 75 $\Omega$ , negative sync., Mini DIN 4-pin $\infty$ 1 (C) 0.286 V (p-p), 75 $\Omega$
Component video output	(Y) 1.0 V (p-p), 75 $\Omega$ , negative sync., pin jack $\infty$ 1 (P <sub>B</sub> )/(P <sub>R</sub> ) 0.7 V (p-p), 75 $\Omega$ , pin jack $\infty$ 2
Audio output (BITSTREAM/PCM COAXIAL)	0.5V (p-p), 75 $\Omega$ , pin jack $\infty$ 1
Audio output (ANALOG)	2.0 V (rms), 680 $\Omega$ , pin jacks (L, R) $\infty$ 1

### Supplied Accessories

Audio/video cable .....	1
Remote control (SE-R0107) .....	1
Batteries (AAA) .....	2

- Designs and specifications are subject to change without notice.

## LIMITED WARRANTY DVD VIDEO PLAYER

---

Toshiba America Consumer Products, Inc. ("TACP") and Toshiba Hawaii, Inc. ("THI") make the following limited warranties to original consumers for DVD Players purchased and used in the United States. THESE LIMITED WARRANTIES EXTEND TO THE ORIGINAL CONSUMER PURCHASER OR ANY PERSON RECEIVING THIS DVD PLAYER AS A GIFT FROM THE ORIGINAL CONSUMER PURCHASER AND TO NO OTHER PURCHASER OR TRANSFEREE.

PRODUCTS PURCHASED IN THE U.S.A. AND USED IN CANADA ARE NOT COVERED BY THESE WARRANTIES.

PRODUCTS PURCHASED IN CANADA AND USED IN THE U.S.A. ARE NOT COVERED BY THESE WARRANTIES.

### Limited One (1) Year Warranty\*

TACP/THI warrants this DVD Player against defects in materials or workmanship for a period of one (1) year after the date of the original retail purchase. DURING THIS PERIOD TACP/THI WILL, AT TACP/THI'S OPTION, REPAIR OR EXCHANGE A DEFECTIVE DVD PLAYER WITH A NEW OR REFURBISHED DVD PLAYER, AT TACP/THI'S OPTION. DURING THE INITIAL NINETY (90) DAYS, THIS REPAIR OR EXCHANGE WILL BE WITHOUT CHARGE TO YOU, EXCEPT YOU MUST PAY FOR ALL TRANSPORTATION AND INSURANCE CHARGES FOR THE DVD PLAYER TO BE SHIPPED TO THE DESIGNATED TACP/THI FACILITY. AFTER THE INITIAL NINETY (90) DAYS AND FOR THE REMAINDER OF THE WARRANTY PERIOD, AN ADDITIONAL HANDLING FEE WILL APPLY. YOU MUST DELIVER THE ENTIRE DVD PLAYER AND ALL ACCESSORIES (SUCH AS POWER CORDS, CABLES, AND THE UNIT'S REMOTE CONTROL DEVICE) TO THE DESIGNATED TACP/THI FACILITY, AS INSTRUCTED BY TACP/THI. TACP/THI IS NOT RESPONSIBLE IF YOUR DVD PLAYER IS LOST OR DAMAGED DURING SHIPMENT.

### \*Commercial Units

DVD Players sold and used for commercial purposes have a limited ninety (90) day warranty.

### Rental Units

The warranty period for rental units begins with the first rental or thirty (30) days from the date of shipment to the rental firm, whichever comes first.

### Owner's Manual and Demographic Card

You should read this owner's manual thoroughly before operating this DVD Player. You should complete and mail the enclosed Demographic Card within ten days after you, or the person who has given you this product as a gift, purchased this DVD Player. This is one way to enable TACP/THI to provide you with better customer service and improved products. Failure to return the Demographic Card will not affect your rights under this warranty.

### Your Responsibility

THE ABOVE LIMITED WARRANTIES ARE SUBJECT TO THE FOLLOWING CONDITIONS:

- (1) You must provide your bill of sale or other proof of purchase. For rental firms, proof of first rental is also required.
- (2) The limited warranties from TACP and THI are effective only if the DVD Player is purchased and operated in the U.S.A. or Puerto Rico.
- (3) Labor service charges for installation, set up, and adjustment of customer controls are not covered by these limited warranties.
- (4) These limited warranties extend only to defects in materials or workmanship as limited above and do not extend to any DVD Player or accessories which have been lost or discarded by you, or to damage to any DVD Player or accessories caused by misuse, accident, Acts of God (such as lightning), or to fluctuations in electric power, improper installation, improper maintenance or use in violation of instructions furnished by TACP/THI; or to units which have been modified or which have had the serial number removed, altered, defaced or rendered illegible.
- (5) Physically damaged DVD Players are not acceptable for repair or exchange whether in or out of warranty and will be returned as received.

### How to Obtain Warranty Services

If, after following all of the operating instructions in this manual and checking the "Troubleshooting" section, you find that service is needed, call one of the following Customer Solutions Centers to obtain further instructions. Have your proof of purchase and your model and serial numbers available when you call.

For DVD Players purchased in the United States, except Hawaii, call TACP, toll free at 1-866-583-7353.

For DVD Players purchased in Hawaii, call THI, at 808-591-9281.

For additional updates, visit TACP's web site:  
[www.toshiba.com/tacp](http://www.toshiba.com/tacp).



**LIMITATION OF IMPLIED WARRANTIES**

ALL WARRANTIES IMPLIED BY THE LAW OF ANY STATE OF THE U.S.A., INCLUDING THE IMPLIED WARRANTIES OF MERCHANTABILITY AND FITNESS FOR A PARTICULAR PURPOSE, ARE EXPRESSLY LIMITED TO THE DURATION OF THE LIMITED WARRANTIES SET FORTH ABOVE.

**Time for Taking Action**

The time within which action must be commenced to enforce any obligation of TACP or THI arising under this limited warranty or under any law of the United States or of any state thereof is hereby limited to 90 days from the date you discovered, or should have discovered, the defect. This limitation does not apply to implied warranties arising under the law of any state of the U.S.A.

**LIMITATION OF WARRANTY**

WITH THE EXCEPTION OF ANY WARRANTIES IMPLIED BY THE LAW OF ANY STATE OF THE U.S.A. AS HEREBY LIMITED, THE FOREGOING LIMITED WARRANTY IS EXCLUSIVE AND IN LIEU OF ALL OTHER WARRANTIES, GUARANTEES, AGREEMENTS AND SIMILAR OBLIGATIONS OF TACP OR THI WITH RESPECT TO YOUR DVD PLAYER.

**HOW STATE LAW RELATES TO WARRANTY**

THIS WARRANTY GIVES YOU SPECIFIC LEGAL RIGHTS, AND YOU MAY ALSO HAVE OTHER RIGHTS WHICH MAY VARY FROM STATE TO STATE IN THE U.S.A.

SOME STATES OF THE U.S.A. DO NOT ALLOW LIMITATIONS ON HOW LONG AN IMPLIED WARRANTY LASTS, WHEN AN ACTION MAY BE BROUGHT, OR THE EXCLUSION OR LIMITATION OF INCIDENTAL OR CONSEQUENTIAL DAMAGES, SO THE ABOVE LIMITATIONS OR EXCLUSIONS MAY NOT APPLY TO YOU UNDER SUCH CIRCUMSTANCES.

**EXCLUSION OF DAMAGES**

IN NO EVENT SHALL TACP OR THI BE LIABLE FOR CONSEQUENTIAL OR INCIDENTAL DAMAGES.

**No Change, Modification, or Extension**

No person, agent, distributor, dealer or company is authorized to change, modify or extend the terms of these limited warranties in any manner whatsoever.

**ATTENTION CANADIAN CONSUMERS:**

Canadian consumers are requested to complete the special Canadian "Warranty Registration Form" enclosed, and forward this completed form with a copy of bill of sale to TOSHIBA OF CANADA to "Register and Validate" their warranty. Product must be purchased from an Authorized Canadian Dealer. Products purchased in the U.S.A. and used in Canada are not covered by these warranties.

Contact: Toshiba of Canada Limited  
Consumer Electronics Group  
191 McNabb Street  
Markham, Ontario L3R 8H2  
(905)-470-5400

Consumer Electronics Group  
22171 Fraserwood Way  
Richmond, B.C. V6W 1J5  
(604)-303-2500

Consumer Electronics Group  
1643 North Service Road  
Droval, QC H9P 1J1  
(514)-856-4100

**IMPORTANT: PACKING AND SHIPPING INSTRUCTION**

When you send the product to a Service Station, you must use the original carton box and packing material, then insert the original carton box containing the unit into another carton using more packing material.

**TOSHIBA**

Printed in China  
811-SD39A1-010